

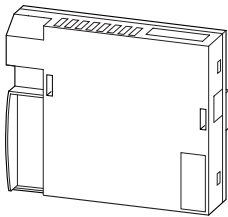

Installation Instructions

Pico GFX-70 Processors

1760-LDF
1760-LDFC
1760-LDFA
1760-LDFCA

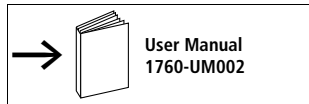

ATTENTION! Electrical Shock Hazard

Only qualified personnel may perform this installation.

Observe all electrical safety requirements, including any applicable laws, regulations, codes and standards when installing this equipment.

Lebensgefahr durch elektrischen Strom!
Nur Elektrofachkräfte und elektrotechnisch unterwiesene Personen dürfen die im Folgenden beschriebenen Arbeiten ausführen.

Die Stromversorgungsgeräte sind Einbaugeräte. Beachten Sie für die Installation der Geräte die länderspezifischen Vorschriften.

Tension électrique dangereuse !

Seules les personnes qualifiées et averties doivent exécuter les travaux ci-après. Les blocs d'alimentation sont des appareils faisant partie intégrante d'une installation. Veuillez respecter les normes de mise en œuvre spécifiques aux différents pays.

Tensione elettrica: Pericolo di morte!

Solo persone abilitate e qualificate possono eseguire le operazioni di seguito riportate. Gli alimentatori sono unità per montaggio interno. Per l'installazione degli apparecchi è necessario rispettare le normative specifiche di ciascun paese.

¡Corriente eléctrica! ¡Peligro de muerte!

El trabajo a continuación descrito debe ser realizado por personas cualificadas y advertidas. Las fuentes de alimentación son aparatos de montaje. Para la instalación de los aparatos han de tenerse en cuenta las normativas/especificaciones a nivel local.

Front view – Frontansicht – Face avant – Vista frontale – Vista de frente

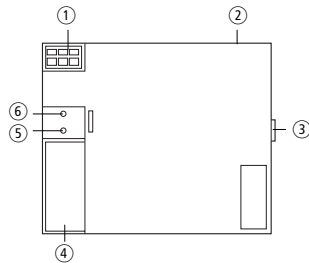

- ① Voltage supply
- ② Pico-Link Terminal
- ③ Expansion Module Connector (1760-RPLCONN)
- ④ Interface (with cover): Slot for memory card, PC interface
- ⑤ Pico-Link LED
- ⑥ Power Supply/Operating Mode LED

- ① Spannungsversorgung
- ② Netzwerkanschluss NET
- ③ Zentrale Kopplung (1760-RPLCONN)
- ④ Schnittstelle (mit Abdeckung): Steckplatz für Speicherkarte, PC-Schnittstelle
- ⑤ NET-LED
- ⑥ Power/RUN-LED

- ① Alimentation
- ② Connecteurs pour mise en réseau (NET)
- ③ Couplage centralisé (1760-RPLCONN)
- ④ Interface (avec capot) : Emplacement pour carte mémoire, interface PC
- ⑤ DEL NET
- ⑥ Tension d'alimentation/DEL RUN

- ① Tensione di alimentazione
- ② Collegamento di rete NET
- ③ Collegamento locale (1760-RPLCONN)
- ④ Interfaccia (con copertura): Posizione di inserimento per la scheda di memoria, slot PC
- ⑤ NET-LED
- ⑥ LED Power/RUN

- ① Tensión de alimentación
- ② Conexión de red NET
- ③ Acoplamiento centralizado (1760-RPLCONN)
- ④ Interface (con tapa): Slot para tarjeta de memoria, interface PC
- ⑤ NET-LED
- ⑥ Cierre/LED de funcionamiento

Standard connection – Standardanschluss – Raccordement standard – Collegamento standard – Conexión estándar

Power supply – Spannungsversorgung – Tension d'alimentation – Tensione di alimentazione – Tensión de alimentación

1760-LDF, 1760-LDFC

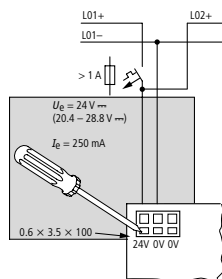

1760-LDFA, 1760-LDFCA

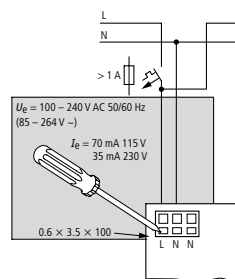

Central expansion – Zentrale Erweiterung – Extension centralisée – Espansione locale – Ampliación centralizada

Fitting ① + ②, removing ③ + ④
 Einbau ① + ②, Ausbau ③ + ④
 Montage ① + ②, démontage ③ + ④
 Montaggio ① + ②, smontaggio ③ + ④
 Montaje ① + ②, desmontaje ③ + ④

 Devices must be de-energized!
 Geräte müssen spannungsfrei sein!
 Assurer la mise hors tension des appareils !
 Gli apparecchi non devono essere alimentati!
 ¡Los aparatos deben encontrarse libres de tensión!

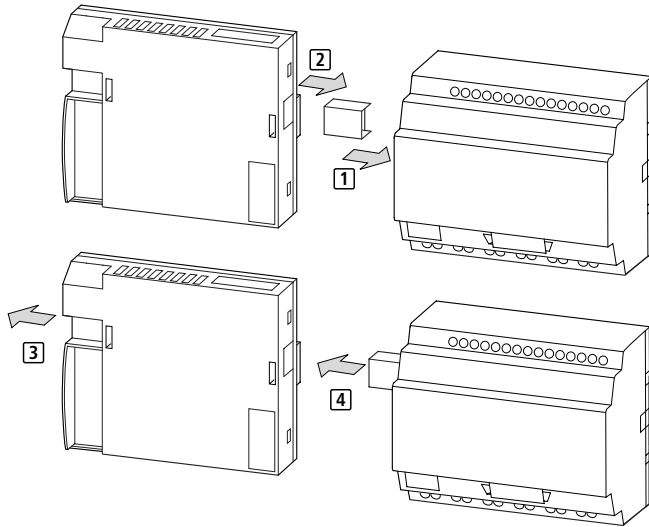

Temperature range:
Temperaturbereich:
Plage de température :
Campo temperatura:
Margen de temperatura:
-25...+55 °C (-13...+131 °F)

- LCD display legible in range 0 to 55 °C (32 °F to 131 °F)
- Do not allow condensation to form on the device!
- LCD-Anzeige im Bereich 0 bis 55 °C lesbar (32 °F bis 131 °F)
- Betauung des Gerätes unbedingt verhindern!
- Afficheur à cristaux liquides lisible dans la plage 0 à 55 °C (32 °F à 131 °F)
- Eviter impérativement toute condensation sur l'appareil !
- Visualizzatore LCD leggibile ad una temperatura compresa da 0 a 55 °C (da 32 °F a 131 °F)
- Impedire assolutamente la formazione di condensa sull'apparecchio!
- El visualizador LCD puede leerse dentro de un margen entre 0 – 55 °C (32 °F – 131 °F)
- ¡Evitar que se produzca condensación en el aparato!

Short-circuit detection
Kurzschlussauswertung
Analyse du court-circuit
Segnale di cortocircuito
Detección de cortocircuitos

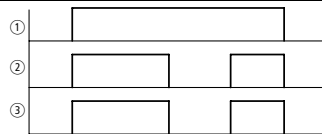

- | | | |
|--|---|--|
| <p>①
 Power supply of the outputs
 Spannungsversorgung der Ausgänge
 Alimentation en tension des sorties
 Tensione di alimentazione delle uscite
 Alimentación de tensión de las salidas</p> | <p>②
 Short-circuit, overload, overtemperature
 Kurzschluss, Überlast, Übertemperatur
 Court-circuit, surcharge, échauffement
 Cortocircuito, sovraccarico, sovratemperatura
 Cortocircuito, sobrecarga, sobretemperatura</p> | <p>③
 Fault detection
 Fehlererkennung
 Détection de défauts
 Riconoscimento errori
 Detección de fallos</p> |
|--|---|--|
- I16 = Q1–Q4
 R16 = S1–S4
 R15 = S5–S8

I14 expansion monitoring
Erweiterungsüberwachung I14
Surveillance module d'extension I14
Monitoraggio modulo d'espansione I14
Control módulo de ampliación I14

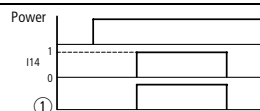

- ① 1760-RPLCONN faulty, cable break
 1760-RPLCONN gestört, Kabelbruch
 Défaut 1760-RPLCONN, rupture de câble
 1760-RPLCONN disturbato, rottura cavo
 1760-RPLCONN erróneo, rotura de cable

①
1760-LDF... interface
Schnittstelle 1760-LDF...
Interface 1760-LDF...
Interfaccia 1760-LDF...
Interface 1760-LDF...

②
1760-MM3 memory module
Speichermodul 1760-MM3
Carte mémoire 1760-MM3
Scheda di memoria 1760-MM3
Tarjeta de memoria 1760-MM3

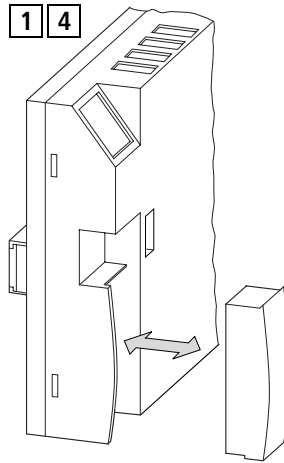

1 Remove sealing cap – Verschlusskappe entfernen – Retirer cache – Rimuovere calotta di chiusura – Quitar tapón

2a 2b fit – stecken – enficher – inserire – meter

3a 3b remove – entfernen – retirer – rimuovere – quitar

4 Fit sealing cap – Verschlusskappe stecken – Enficher cache – Inserire calotta di chiusura – Meter tapón



Warning!
 The interface must be kept closed.
 Electrostatic discharges may destroy the device if the interface is open.

Warnung!
 Die Schnittstelle ist geschlossen zu halten.
 Elektrostatische Entladungen können bei geöffneter Schnittstelle das Gerät zerstören.

Avertissement !
 Lorsqu'aucun connecteur n'est enfiché dans l'interface, cette dernière doit impérativement être obturée à l'aide du capot prévu à cet effet (fourni avec l'appareil). Dans le cas contraire, des décharges électrostatiques risquent d'endommager gravement l'appareil et de le rendre inutilisable.

Avvertimento!
 L'interfaccia deve restare chiusa. Scariche elettrostatiche con interfaccia aperta possono distruggere l'apparecchio.

¡Advertencia!
 La interface debe permanecer cerrada.
 De lo contrario, descargas electrostáticas podrían dañar el aparato.

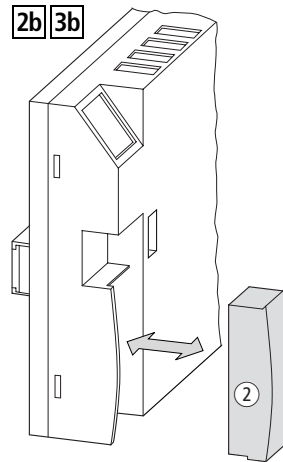
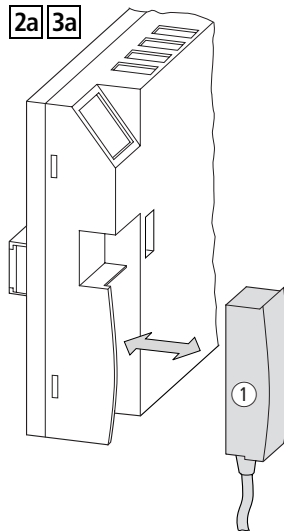

Terminal operation
Terminal-Betrieb
Funzionamento terminale
Funcionamiento terminal
Funcionamiento terminal

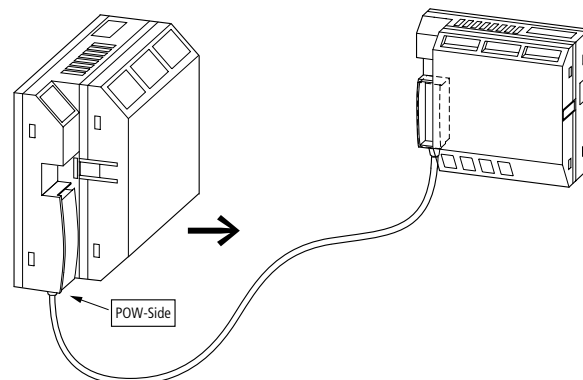

Flush mounting – Frontmontage – Montage encastré – Montaggio frontale – Montaje frontal

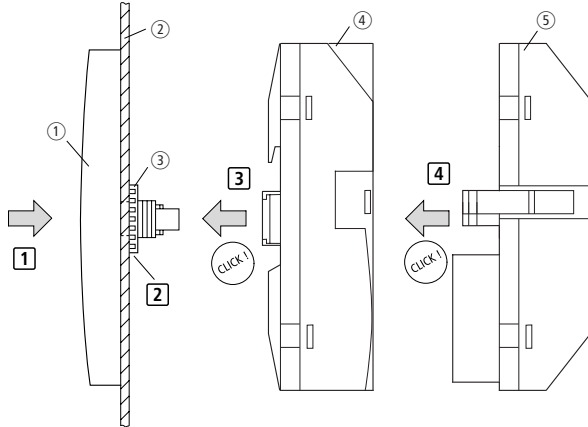

Warning! Risk of destruction !
Only permitted if the device is de-energized !

Warnung ! Zerstörungsgefahr!
Nur im spannungsfreien Zustand erlaubt!

Avertissement ! Risque de destruction !
Rischio di distruzione! Autorisé hors tension seulement !

Avvertimento ! Rischio di distruzione!
Consentito solo in assenza di tensione!

¡Advertencia! ¡Peligro de destrucción!
¡Se permite sólo en estado libre de tensión!

Ⓜ M = 1.2 – 2 Nm
10.6 – 17.7 lbin

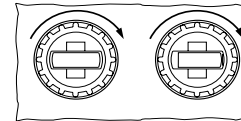

(EN)

- ① 1760-DU...
- ② Enclosure plate: 1760-LDF... with DIN rail 1 to 4 mm (0.04 to 0.16"), others 1 to 6 mm (0.04 to 0.24")
- ③ Fixing ring
- ④ 1760-LDF... (mains power unit CPU)
- ⑤ 1760-IA12XOW4I, 1760-IB12XOW4I..., 1760-IB12XOB4I... (I/O module)

- Ⓜ Fit 1760-DU...
- Ⓜ Fixing 1760-DU...
- Ⓜ Fitting 1760-LDF...
- Ⓜ Fitting 1760-IB12.. (optional)

(IT)

- ① 1760-DU...
- ② Parete della custodia: 1760-LDF... con guida DIN a scatto da 1 a 4 mm (0.04 a 0.16"), altrimenti da 1 a 6 mm (0.04 a 0.24")
- ③ Anello di fissaggio
- ④ 1760-LDF... (alimentatore CPU)
- ⑤ 1760-IA12XOW4I, 1760-IB12XOW4I..., 1760-IB12XOB4I... (modulo di I/O)

- Ⓜ Inserire 1760-DU...
- Ⓜ Fissare 1760-DU...
- Ⓜ Inserire 1760-LDF...
- Ⓜ Inserire il modulo di I/O 1760-IB12.. (opzionale)

(DE)

- ① 1760-DU...
- ② Gehäusewand: 1760-LDF... mit Hutschiene 1 bis 4 mm (0.04 bis 0.16"), sonst 1 bis 6 mm (0.04 bis 0.24")
- ③ Befestigungsring
- ④ 1760-LDF... (Netzteil CPU)
- ⑤ 1760-IA12XOW4I, 1760-IB12XOW4I..., 1760-IB12XOB4I... (E/A-Baugruppe)

- Ⓜ 1760-DU... stecken
- Ⓜ 1760-DU... befestigen
- Ⓜ 1760-LDF... stecken
- Ⓜ 1760-IB12.. stecken (optional)

(ES)

- ① 1760-DU...
- ② Pared de caja: 1760-LDF... con guía simétrica 1 a 4 mm (0.04 a 0.16"), en otro caso 1 a 6 mm (0.04 a 0.24")
- ③ Anillo de fijación
- ④ 1760-LDF... (alimentación unidad central)
- ⑤ 1760-IA12XOW4I, 1760-IB12XOW4I..., 1760-IB12XOB4I... (módulo E/S)

- Ⓜ Enchufar 1760-DU...
- Ⓜ Fijar 1760-DU...
- Ⓜ Enchufar 1760-LDF...
- Ⓜ Enchufar módulo 1760-IB12.. (opcional)

(FR)

- ① 1760-DU...
- ② Paroi du boîtier: 1760-LDF... avec profilé-support 1 à 4 mm, (0.04 à 0.16") sinon 1 à 6 mm (0.04 à 0.24")
- ③ Collierette de fixation
- ④ 1760-LDF... (alimentation UC)
- ⑤ 1760-IA12XOW4I, 1760-IB12XOW4I..., 1760-IB12XOB4I... (module E/S)

- Ⓜ Enficher 1760-DU...
- Ⓜ Fixation 1760-DU...
- Ⓜ Enficher 1760-LDF...
- Ⓜ Enficher module 1760-IB12.. (optional)

Dismantling the device – Démontage des Gerätes – Démontrage d'appareil – Smontaggio dell'apparecchio – Desmontaje del aparato

Remove I/O module – E/A-Baugruppe entfernen – Retirer module E/S – Rimuovere il modulo di I/O – Quitar módulo E/S

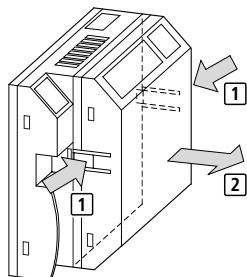

- Ⓜ Press interlock – Verriegelung zusammen drücken – Presser sur le verrouillage – Premere il blocco – Presionar el enclavamiento
- Ⓜ Remove I/O module – E/A-Baugruppe abziehen – Retirer module E/S – Rimuovere il modulo di I/O – Quitar módulo E/S

Warning! Risk of destruction !
Only permitted if the device is de-energized !

Warnung ! Zerstörungsgefahr!
Nur im spannungsfreien Zustand erlaubt!

Avertissement ! Risque de destruction !
Rischio di distruzione! Autorisé hors tension seulement !

Avvertimento ! Rischio di distruzione!
Consentito solo in assenza di tensione!

¡Advertencia! ¡Peligro de destrucción!
¡Se permite sólo en estado libre de tensión!

Remove processor from 1760-DU... – CPU-Baugruppe von 1760-DU... entfernen – Retirer le module UC du 1760-DU... – Rimuovere il modulo CPU dall'1760-DU... – Quitar unidad central de 1760-DU...

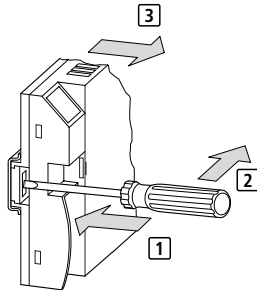

- 1 Insert screwdriver – Schraubendreher ansetzen – Engager un tournevis – Inserire il cacciavite – Colocar el destornillador
- 2 Actuate slide – Schieber betätigen – Actionner le coulisseau – Attivare la saracinesca – Accionar la corredera
- 3 Remove CPU – CPU-Einheit abziehen – Retirer l'unité centrale (UC) – Estrarre l'unità CPU – Extraer la unidad CPU

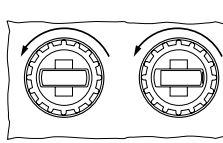

- 1 Loosen and remove fixing rings. Befestigungsringe lösen und entfernen. Desserrer et retirer colerettes de fixation. Allentare e rimuovere gli anelli di fissaggio. Soltar y quitar anillos de fijación.

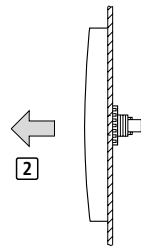

- 2 Remove 1760-DU... 1760-DU... entfernen Retirer 1760-DU... Rimuovere 1760-DU... Quitar 1760-DU...

Mounting the expansion modules with front mounting – Montage der Erweiterungsgeräte bei Frontbefestigung – Montage des extensions en cas de fixation avant – Montaggio dei moduli di espansione con fissaggio frontale – Montaje de los aparatos de ampliación con fijación frontal

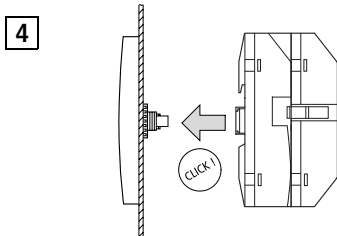
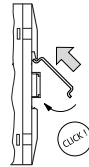
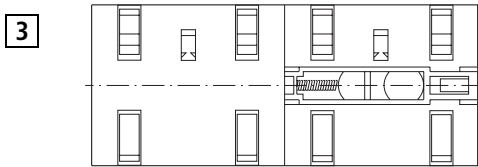
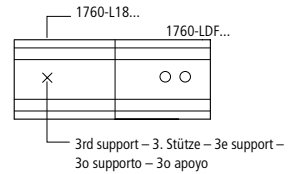
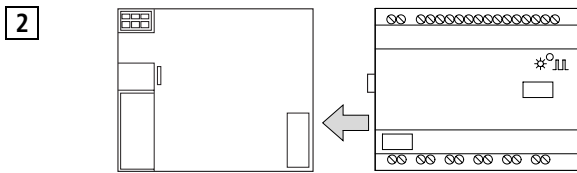
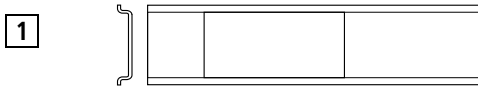

Dismantling – Demontage – Démontage – Smontaggio – Desmontaje 4 → 3 → 2

Mounting – Montage – Montaggio – Montaje

on 35 mm DIN rail – auf 35-mm-Hutschiene – sur profilé-support 35 mm – su guida DIN 35 mm – sobre guía simétrica de 35 mm

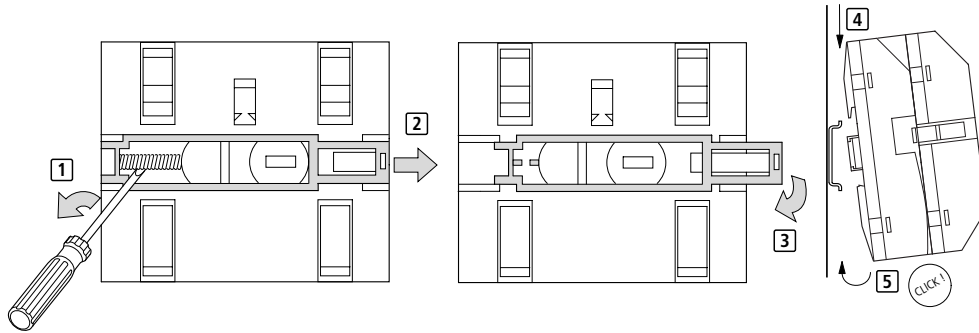

on mounting plate (horizontal)
auf Montageplatte (waagrecht)
sur plaque de montage (horizontale)
su piastra di montaggio (orizzontale)
sobre placa de montaje (horizontal)

1760-NMF

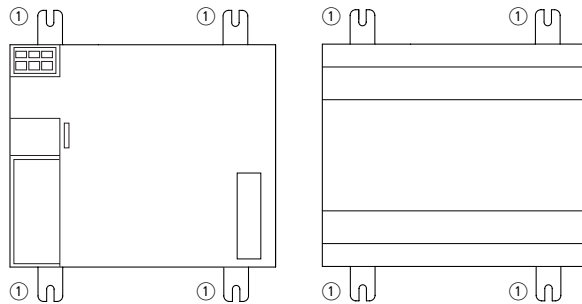
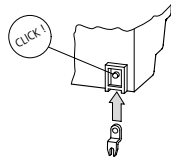

- ① 3 mounting feet sufficient
- 3 Gerätefüße ausreichend
- 3 pattes de fixation suffisent
- 3 piedini di fissaggio sufficienti
- 3 pies de sujeción adecuados

Mounting position – Einbaulage – Position de montage – Posizione di montaggio – Posición de montaje

with DIN rail (horizontal and vertical)
mit Hutschiene (waagrecht und senkrecht)
sur profilé chapeau (horizontale et verticale)
su guida DIN (orizzontale e verticale)
sobre carril (horizontal y vertical)

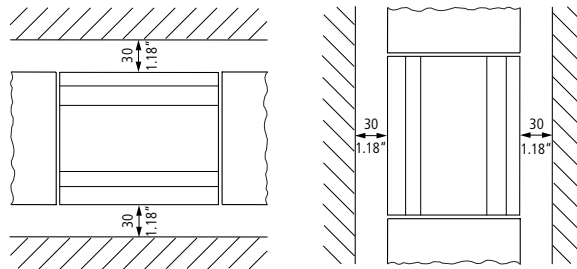

Dimensions – Abmessungen – Dimensioni – Dimensiones

1760-LDF...

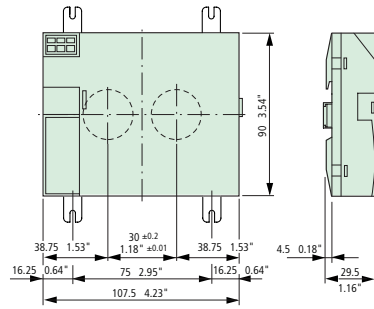

1760-DU... + 1760-LDF... + 1760-IB12XOW.../1760-IB12XOB...

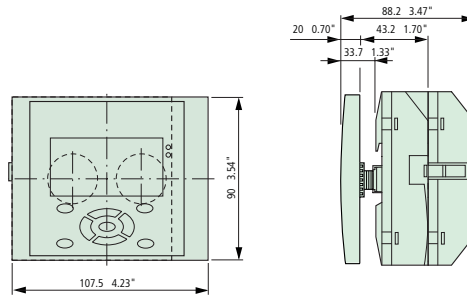

1760-IB12XOW..., 1760-IB12XOB...

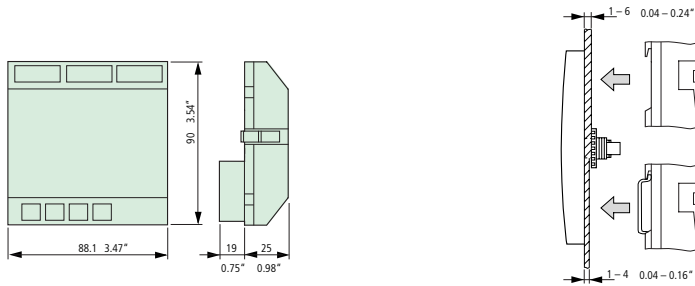

3rd support – 3. Stütze – 3e support – 3o supporto – 3o apoyo

Top-hat rail (DIN) with cut-out – Hutschiene mit Ausschnitt – Profilé-support avec découpe – Guida DIN a scatto con apertura – Guía simétrica con sección

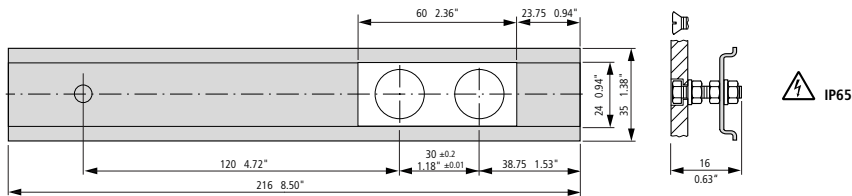

1760-L18...

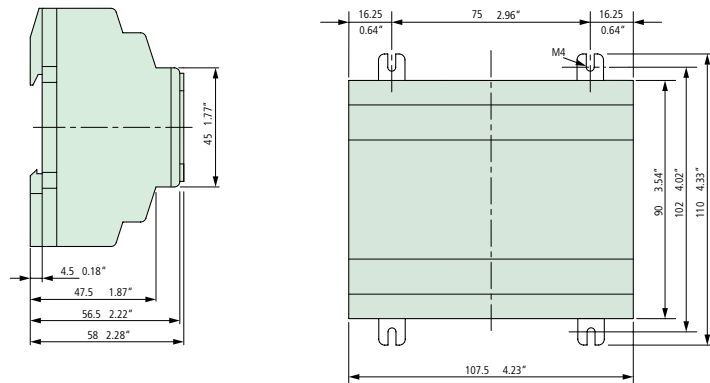

Template for holes, scale 1 : 1
Bohrschablone M 1 : 1
Gabarit de perçage, échelle 1 : 1
Dima di foratura, scala 1 : 1
Plantilla para taladros, escala 1 : 1

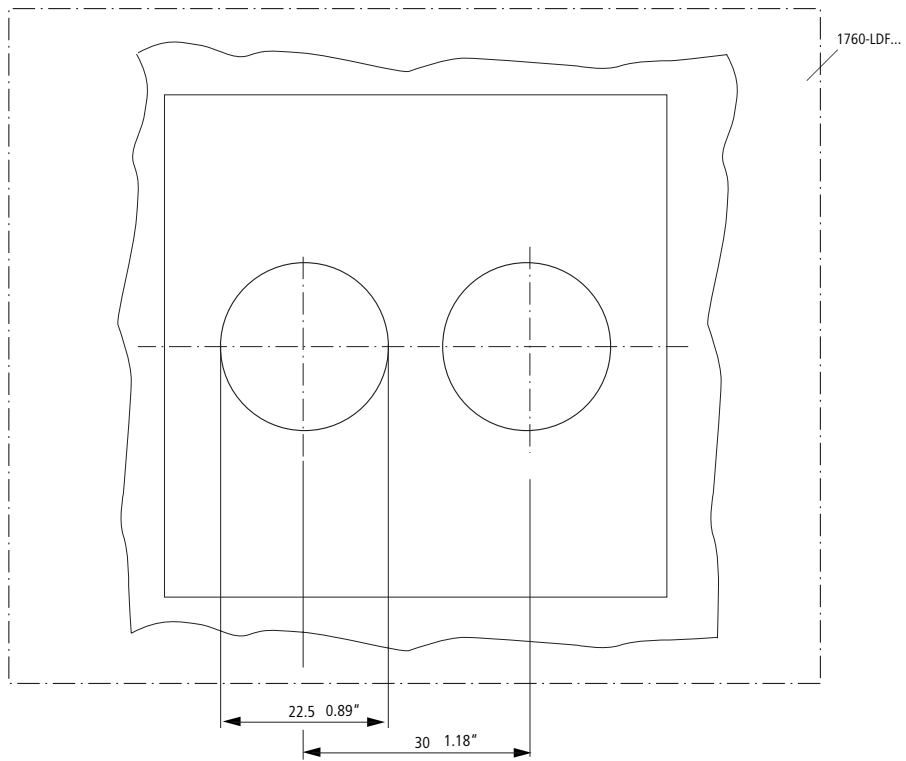

For More Information

For	Refer to this Document	Pub Number
A more detailed description of how to install and use your Pico GFX-70 controller.	Pico GFX-70 Controller User Manual	1760-UM002
An introduction to Pico GFX-70 programming.	Pico GFX-70 Controllers Quick Start	1760-QS002
A more detailed description of how to install and use your Pico controller.	Pico Controller User Manual	1760-UM001
A basic overview of Pico and an introduction to Pico programming.	Pico Controller Getting Results	1760-GR001
More information on proper wiring and grounding techniques.	Industrial Automation Wiring and Grounding Guidelines	1770-4.1

If you would like a manual, you can:

- download a free electronic version from the internet: www.ab.com/pico or www.literature.rockwellautomation.com
- order a printed manual by contacting your local distributor or Rockwell Automation representative

Weitere Informationen

Für	Siehe Dokument	Pub.-Nr.
Eine ausführlichere Beschreibung der Installation und Handhabung Ihrer programmierbaren Steuerung Pico GFX-70.	Steuerung Pico GFX-70 Benutzerhandbuch	1760-UM002
Eine Einführung zur Programmierung von Pico GFX-70.	Kurzanleitung Pico GFX-70 Regler	1760-QS002
Eine ausführlichere Beschreibung der Installation und Handhabung Ihrer programmierbaren Steuerung Pico.	Steuerung Pico™ Benutzerhandbuch	1760-UM001
Eine grundlegende Übersicht über Pico und eine Einführung in die Pico-Programmierung.	Steuerung Pico™ Praxishandbuch	1760-GR001
Weitere Informationen über ordnungsgemäße Verdrahtungs- und Erdungsverfahren.	Richtlinien zur Verdrahtung und Erdung von industriellen Automatisierungssystemen	1770-4.1DE

Zu diesem Produkt gibt es ein Benutzerhandbuch, das Sie wie folgt bestellen können:

- durch kostenloses Herunterladen vom Internet: www.ab.com/pico oder www.literature.rockwellautomation.com
- durch Bestellung:
bei Ihrem Distributor oder einer Niederlassung von Rockwell Automation in Ihrer Nähe

Pour en savoir plus

Pour	Lisez ce document	Référence
Plus de détails sur l'installation et l'utilisation de l'automate Pico GFX-70.	Module Pico GFX-70 Manuel utilisateur	1760-UM002
Introduction à la programmation du Pico GFX-70.	Guide rapide regulateurs Pico GFX-70	1760-QS002
Plus de détails sur l'installation et l'utilisation de l'automate Pico.	Module Pico™ Manuel utilisateur	1760-UM001
Présentation générale de Pico et introduction à la programmation Pico.	Module Pico™ Guide pratique	1760-GR001
Plus d'informations sur le câblage et les techniques de mise à la terre.	Directives de câblage et de mise à la terre pour automatisation industrielle	1770-4.1FR

Pour vous procurer un manuel, vous pouvez :

- le charger gratuitement depuis le site Internet : www.ab.com/pico ou www.literature.rockwellautomation.com
- commander un manuel imprimé. Pour cela :
contactez votre distributeur local Rockwell Automation

Per ulteriori informazioni

Per	Vedere documento	N. Pub.
Avere descrizioni più dettagliate su come installare e usare il controllore Pico GFX-70.	Controllore Pico GFX-70 Manuale dell'utente	1760-UM002
Introduzione alla programmazione del Pico GFX-70.	Guida rapida regolatori Pico GFX-70	1760-QS002
Avere descrizioni più dettagliate su come installare e usare il controllore Pico.	Controllore Pico™ Manuale dell'utente	1760-UM001
Informazioni generali su Pico e sulla sua programmazione.	Controllore Pico™ Per essere operativi	1760-GR001
Avere ulteriori informazioni sui modi appropriati di cablaggio e della messa a terra.	Industrial Automation Wiring and Grounding Guidelines	1770-4.11T

Se si desidera ricevere un manuale, è possibile:

- scaricare una versione elettronica gratis da internet al sito: www.ab.com/pico o www.literature.rockwellautomation.com
- ordinare un manuale stampato:
contattando il distributore locale o rappresentante della Rockwell Automation

Para obtener más información

Para	Consulte este documento	Núm. de Publicación
Una descripción detallada sobre cómo instalar y usar el controlador Pico GFX-70.	Controlador Pico GFX-70 Manual del usuario	1760-UM002
Introducción de la programación de Pico GFX-70.	Guía rápida controladores Pico GFX-70	1760-QS002
Una descripción detallada sobre cómo instalar y usar el controlador Pico.	Controlador Pico™ Manual del usuario	1760-UM001
Vista general de Pico e introducción a la programación Pico.	Controlador Pico™ Obtención de resultados	1760-GR001
Información adicional sobre las técnicas apropiadas de cableado y tierra.	Pautas sobre cableado y conexión a tierra de equipos de automatización industrial	1770-4.1ES

Si quiere recibir un manual puede:

- descargar una versión electrónica gratis de la siguiente dirección de internet: www.ab.com/pico or www.literature.rockwellautomation.com
- pedir un manual impreso. Para hacer esto haga una de las siguientes cosas:
comuníquese con su distribuidor local o representante local de Rockwell Automation

HAZARDOUS LOCATION – CSA (Canadian Standards Association) Certification

This equipment is suitable for use in CLASS I, DIVISION 2, GROUPS A, B, C AND D

WARNING: "EXPLOSION HAZARD – DO NOT DISCONNECT WHILE CIRCUIT IS LIVE UNLESS AREA IS KNOWN TO BE NON-HAZARDOUS"

EMPLACEMENTS DANGEREUX – Certification CSA (Canadian Standards Association)

Cet équipement est acceptable pour utilisation dans les EMBLEMES DANGEREUX DE CLASSE I, DIVISION 2, GROUPES A, B, C ET D

AVERTISSEMENT : « RISQUE D'EXPLOSION. NE PAS DÉBRANCHER TANT QUE LE CIRCUIT EST SOUS TENSION, A MOINS QU'IL NE S'AGISSE D'UN EMBLEMES NON DANGEREUX »

www.rockwellautomation.com

Corporate Headquarters

Rockwell Automation, 777 East Wisconsin Avenue, Suite 1400, Milwaukee, WI, 53202-5302 USA, Tel: (1) 414.212.5200, Fax: (1) 414.212.5201

Headquarters for Allen-Bradley Products, Rockwell Software Products and Global Manufacturing Solutions

Americas: Rockwell Automation, 1201 South Second Street, Milwaukee, WI 53204-2496 USA, Tel: (1) 414.382.2000, Fax: (1) 414.382.4444

Europe/Middle East/Africa: Rockwell Automation SA/NV, Vorstlaan/Boulevard du Souverain 36, 1170 Brussels, Belgium, Tel: (32) 2 663 0600, Fax: (32) 2 663 0640

Asia Pacific: Rockwell Automation, Level 14, Core F, Cyberport 3, 100 Cyberport Road, Hong Kong, Tel: (852) 2887 4788, Fax: (852) 2508 1846

Headquarters for Dodge and Reliance Electric Products

Americas: Rockwell Automation, 6040 Ponders Court, Greenville, SC 29615-4617 USA, Tel: (1) 864.297.4800, Fax: (1) 864.281.2433

Europe/Middle East/Africa: Rockwell Automation, Herman-Heinrich-Gossen-Strasse 3, 50858 Köln, Germany, Tel: 49 (0) 2234 379410, Fax: 49 (0) 2234 3794164

Asia Pacific: Rockwell Automation, 55 Newton Road, #11-01/02 Revenue House, Singapore 307987, Tel: (65) 6356 9077, Fax: (65) 6356 9011

Publication 1760-IN004E-MU-P January 2006
Supersedes 1760-IN004D-MU-P April 2005
Printed in the Federal Republic of Germany (01/06)

PN 40071-174-01(5)
© 2006 Rockwell Automation Inc.
12268428 Doku/EB