



Allen-Bradley

Pico Controllers

Bulletin 1760

User Manual

**Rockwell
Automation**

Important User Information

Solid state equipment has operational characteristics differing from those of electromechanical equipment. *Safety Guidelines for the Application, Installation and Maintenance of Solid State Controls* (Publication SGI-1.1 available from your local Rockwell Automation sales office or online at <http://www.ab.com/manuals/gi>) describes some important differences between solid state equipment and hard-wired electromechanical devices. Because of this difference, and also because of the wide variety of uses for solid state equipment, all persons responsible for applying this equipment must satisfy themselves that each intended application of this equipment is acceptable.

In no event will Rockwell Automation, Inc. be responsible or liable for indirect or consequential damages resulting from the use or application of this equipment.

The examples and diagrams in this manual are included solely for illustrative purposes. Because of the many variables and requirements associated with any particular installation, Rockwell Automation, Inc. cannot assume responsibility or liability for actual use based on the examples and diagrams.

No patent liability is assumed by Rockwell Automation, Inc. with respect to use of information, circuits, equipment, or software described in this manual.

Reproduction of the contents of this manual, in whole or in part, without written permission of Rockwell Automation, Inc. is prohibited.

Throughout this manual, when necessary we use notes to make you aware of safety considerations.

WARNING

Identifies information about practices or circumstances that can cause an explosion in a hazardous environment, which may lead to personal injury or death, property damage, or economic loss.

IMPORTANT

Identifies information that is critical for successful application and understanding of the product.

ATTENTION

Identifies information about practices or circumstances that can lead to personal injury or death, property damage, or economic loss. Attentions help you:

- identify a hazard
 - avoid a hazard
 - recognize the consequence
-

SHOCK HAZARD

Labels may be located on or inside the equipment (e.g., drive or motor) to alert people that dangerous voltage may be present.

BURN HAZARD

Labels may be located on or inside the equipment (e.g., drive or motor) to alert people that surfaces may be dangerous temperatures.

Summary of Changes

The information below summarizes the changes to this manual since the last printing as publication 1760-UM001C-EN-P, April 2005.

To help you locate new and updated information in this release of the manual, we have included change bars as shown to the right of this paragraph.

Catalog Number Release History

The following table shows the history of Pico catalog numbers.

Description	Released June 2000	Release August 2001	Release March 2005
120/240V ac Pico	1760-L12AWA	1760-L18AWA-EX	1760-L18AWA-EXND
	1760-L12AWA-NC		
	1760-L12AWA-ND		
	1760-L18AWA		
24V dc Pico	1760-L12BWB	1760-L12BWB-ND	1760-L12BBB
	1760-L12BWB-NC	1760-L18BWB-EX	1760-L12BBB-ND
			1760-L18BWB-EXND
			1760-L18DWD-EX
			1760-L20BBB-EX
1760-L20BBB-EXND			
12V dc Pico		1760-L12DWD	1760-L18DWD-EXND
			1760-L12DWD-ND
24V ac Pico			1760-L12NWN
			1760-L12NWN-ND
			1760-L18NWN-EX
			1760-L18NWN-EXND
Expansion Modules		1760-IA12XOW6I	1760-IA12XOW4I
		1760-IB12XOB8	1760-IB12XOW6I
Expansion Module Connector ⁽¹⁾		1760-RPLCONN	
Memory Modules	1760-MM1		1760-MM2B
	1760-MM2		
Input/Output Simulator	1760-SIM		
Programming Software	1760-PICOSOFT		
Programming Cable	1760-CBL-PM02		

(1) Included with expansion module. Catalog Number is listed as a replacement part.

New Information

The table below lists sections where new information has been added.

For This New Information	See
Changed Catalog Number 1760-L12NWA and 1760-L18NWA to 1760-L12NWN and 1760-L18NWN.	Throughout manual
Changed inputs to 24V ac.	page A-5

Preface	Who Should Use this Manual	Preface-1
	Purpose of this Manual	Preface-1
	Common Techniques Used in this Manual	Preface-2
	Rockwell Automation Support	Preface-3
	 Chapter 1	
System Overview	Overview	1-1
	Hardware Versions	1-2
	Operating Principles	1-6
	 Chapter 2	
Installation	Prevent Electrical Shock	2-1
	European Communities (EC) Directive Compliance	2-2
	Connect the Expansion Module	2-3
	Mount the Pico Controller	2-3
	Install the Remote Processor	2-6
	Wire Terminals	2-8
	Connect the Incoming Power	2-9
	Use Surge Suppressors	2-12
	Connect the Inputs	2-14
	Connect Outputs	2-22
	Connect Relay Outputs	2-22
	Connect Transistor Outputs	2-24
	 Chapter 3	
Commission the Pico	Power On Unit	3-1
	Set the Menu Language	3-2
	Modes of Operation	3-3
	Create a Circuit Diagram (Program)	3-4
	 Chapter 4	
Draw a Circuit Diagram with Pico	Pico Operation	4-1
	Work with Contacts and Relays	4-8
	Function Relay Types	4-19
	Example with Timing and Counter Relays	4-21
	Timing Relays	4-26
	Counter Relays	4-32
	High Speed Counters	4-36
	Time Switch	4-42
	Analog Comparators	4-47
	Text Display	4-50
	Jumps	4-53
	Example Programs	4-55

	Chapter 5	
Save and Load Circuit Diagrams	Interface to Memory Module and Programming Cable	5-1
	Memory Module	5-2
	PicoSoft	5-5
	Chapter 6	
Pico System Settings	Password Protection	6-1
	Change the Menu Language	6-6
	Change Parameters	6-7
	Set Date, Time, and Daylight Saving Time	6-9
	Change Between Winter/Summer Time (Daylight Saving Time)	6-10
	Activate Debounce (Input Delay).	6-10
	Activate and Deactivate P-Buttons	6-11
	Start-Up Behavior	6-12
	Set Cycle Time	6-14
	Retention	6-15
	Display Device Information.	6-17
	Chapter 7	
Retention	What is Retention?.	7-1
	Set Retention	7-2
	Delete Retentive Actual Values	7-2
	Transfer Retentive Behavior.	7-3
	Retentive Auxiliary Relays (Markers)	7-4
	Retentive Timing Relays	7-8
	Retentive Up/Down Counters C7 and C8	7-14
	Chapter 8	
Inside Pico	Circuit Diagram Cycle	8-1
	Determine Cycle Time of Circuit Diagrams.	8-3
	Delay Times for Inputs and Outputs	8-7
	Chapter 9	
Use of Expansion Modules	Overview	9-1
	Operation.	9-2
	Module Status Example	9-5
	Chapter 10	
Troubleshoot Your Controller	Messages from the Pico System	10-1
	Possible Situations When Creating Circuit Diagrams	10-2
	Event	10-3

DC Simulator	Chapter 11
	Description 11-1
	Installation Guidelines. 11-2
Specifications	Appendix A
	Physical Specifications. A-1
	Environmental Specifications A-1
	Electrical Specifications A-2
	Power Supply A-3
	Inputs. A-5
	Outputs A-10
	Cycle Time A-13
	Dimensions. A-14
Circuit Diagram Form	Appendix B
	Glossary
	Index

Read this preface to familiarize yourself with the rest of the manual. It provides information concerning:

- who should use this manual
- the purpose of this manual
- related documentation
- conventions used in this manual
- Rockwell Automation support

Who Should Use this Manual

Use this manual if you are responsible for designing, installing, programming, or troubleshooting control systems that use Pico controllers.

You should have a basic understanding of electrical circuitry and familiarity with relay logic. If you do not, obtain the proper training before using this product.

Purpose of this Manual

This manual is a reference guide for Pico controllers. It describes the procedures you use to install, wire, and troubleshoot Pico.

Refer to publication 1760-GR001, Pico Controller Getting Results Manual for a basic overview of Pico and an introduction to Pico programming. ■

Related Documentation

The following documents contain additional information concerning Rockwell Automation products. To obtain a copy, contact your local Rockwell Automation office or distributor.

For	Read this Document	Document Number
A basic overview of Pico and an introduction to Pico programming.	Pico Controller Getting Results Manual	1760-GR001
In-depth information on grounding and wiring Allen-Bradley programmable controllers	Allen-Bradley Programmable Controller Grounding and Wiring Guidelines	1770-4.1
A description of important differences between solid-state programmable controller products and hard-wired electromechanical devices	Application Considerations for Solid-State Controls	SIG-1.1
An article on wire sizes and types for grounding electrical equipment	National Electrical Code - Published by the National Fire Protection Association of Boston, MA.	
A complete listing of current documentation, including ordering instructions. Also indicates whether the documents are available on CD-ROM or in multi-languages.	Allen-Bradley Publication Index	SD499
A glossary of industrial automation terms and abbreviations	Allen-Bradley Industrial Automation Glossary	AG-7.1

Common Techniques Used in this Manual

The following conventions are used throughout this manual:

- Bulleted lists such as this one provide information, not procedural steps.
- Numbered lists provide sequential steps or hierarchical information.

Rockwell Automation Support

Rockwell Automation offers support services worldwide, with over 75 Sales/Support Offices, 512 authorized Distributors and 260 authorized Systems Integrators located throughout the United States alone, plus Rockwell Automation representatives in every major country in the world.

Local Product Support

Contact your local Rockwell Automation representative for:

- sales and order support
- product technical training
- warranty support
- support service agreements

Technical Product Assistance

If you need to contact Rockwell Automation for technical assistance, please review the Troubleshooting section on page 10-1 in this manual first. Then call your local Rockwell Automation representative.

You can also find a local Rockwell Automation Technical Support contact at:

- <http://support.automation.rockwell.com/contactinformation/>

Your Questions or Comments on this Manual

If you find a problem with this manual, or you have any suggestions for how this manual could be made more useful to you, please contact us at the address below:

Rockwell Automation
Control and Information Group
Technical Communication, Dept. A602V
P.O. Box 2086
Milwaukee, WI 53201-2086

or visit our internet page at:

<http://www.ab.com/pico> or <http://www.rockwellautomation.com>

System Overview

Overview

Pico is an electronic control relay with built-in logic, timer, counter, and real-time clock functions. Pico is a control and input device that can perform a variety of tasks in building and machine applications.

Pico is programmed using ladder diagrams. Each programming element is entered directly via the Pico display. For example, you can:

- connect make and break contacts in series and in parallel,
- connect output relays and markers,
- define outputs as relays, flip-flop relays or latching relays,
- select timing relays with different functions,
- assign eight up and down counters,
- display text with variables,
- track the flow of current in the program, and
- load, save and password-protect programs.

Most controllers also offer a real-time clock, allowing up to 32 separate on and off times.

The dc versions can receive analog signals at two inputs and evaluate the signals with eight analog comparators.

If you prefer to program Pico from a PC, use PicoSoft programming software. PicoSoft allows you to create and test your programs on the PC. It also enables you to print out your programs in DIN, ANSI or Pico format.

Hardware Versions

Pico Controllers

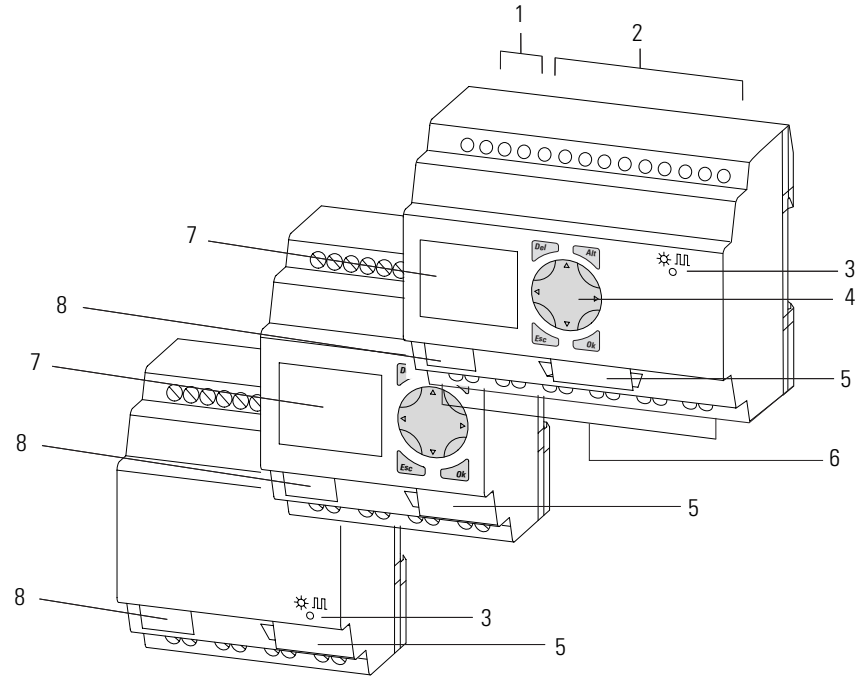

Item	Description
1	Incoming Power
2	Inputs
3	Status LED
4	Buttons
5	Socket for memory module or PC interface cable
6	Outputs
7	LCD display
8	Write-On Surface

Pico controllers are available for 12V dc, 24V dc, 24V ac and 120/240V ac operation and come in both 12-I/O and 18-I/O sizes. Pico is available with and without a real-time clock, and with and without a display and keypad. See the following table for details.

Catalog Number	Inputs	Outputs	Line Power	Real Time Clock	Display and Keypad	Analog	
1760-L12AWA	8 (100 to 240V ac)	4 (relay)	100 to 240V ac	Yes	Yes	No	
1760-L12AWA-NC ⁽¹⁾				No	Yes		
1760-L12AWA-ND ⁽²⁾				Yes	No		
1760-L18AWA	12 (100 to 240V ac)	6 (relay)		Yes	Yes		
1760-L18AWA-EX ⁽³⁾				Yes	Yes		
1760-L18AWA-EXND ⁽²⁾⁽³⁾				Yes	No		
1760-L12BWB	8 (24V dc)	4 (relay)	24V dc	Yes	Yes	2 (0 to 10V dc)	
1760-L12BWB-NC ⁽¹⁾				No	Yes		
1760-L12BWB-ND ⁽²⁾				Yes	No		
1760-L12BBB		4 (MOSFET)		Yes	Yes	2 (0 to 10V dc)	
1760-L12BBB-ND				Yes	No		
1760-L12NWN	8 (24V ac)	4 (relay)	24V ac	Yes	Yes		
1760-L12NWN-ND			24V ac	Yes	No		
1760-L12DWD	8 (12V dc)		12V dc	Yes	Yes		
1760-L12DWD-ND				Yes	No		
1760-L18BWB-EX ⁽³⁾	12 (24V dc)	6 (relay)	24V dc	Yes	Yes		
1760-L18BWB-EXND ⁽²⁾⁽³⁾		6 (relay)		Yes	No		2 (0 to 10V dc)
1760-L20BBB-EX ⁽³⁾		8 (MOSFET)		Yes	Yes		4 (0 to 10V dc)
1760-L20BBB-EXND ⁽²⁾⁽³⁾		8 (MOSFET)		Yes	No		
1760-L18DWD-EX ⁽³⁾	12 (12V dc)	6 (relay)	12V dc	Yes	Yes		
1760-L18DWD-EXND ⁽²⁾⁽³⁾		6 (relay)	12V dc	Yes	No		
1760-L18NWN-EX ⁽³⁾	12 (24V ac)	6 (relay)	24V ac	Yes	Yes	4 (0 to 10V dc)	
1760-L18NWN-EXND ⁽²⁾⁽³⁾	12 (24V ac)	6 (relay)		Yes	No		

(1) NC = no real time clock

(2) ND = no display

(3) EX = suitable for use with expansion modules

Expansion Modules

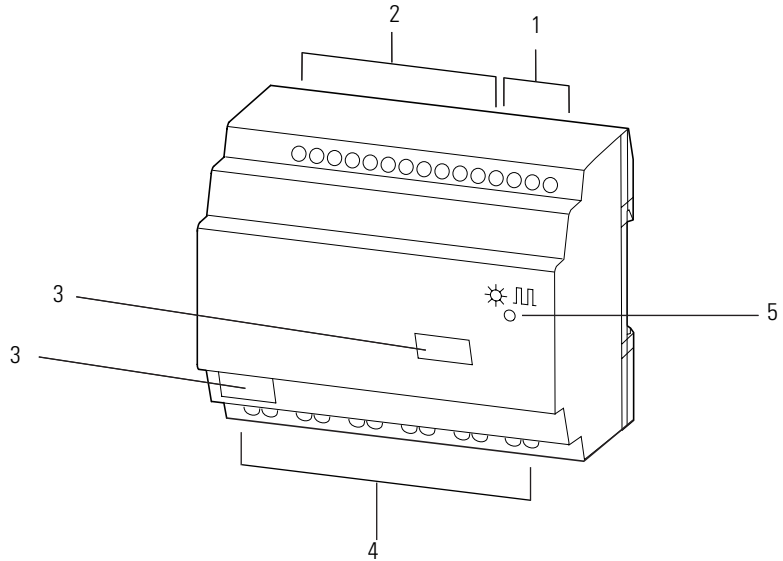

Item	Description
1	Incoming Power
2	Inputs
3	Write-On Surface
4	Outputs
5	Status LED

Use Pico expansion modules with Pico '-EX' models to increase your I/O capacity. The following modules are available.

Catalog Number	Inputs	Outputs	Line Power
1760-IA12XOW6I	12 (100 to 240V ac)	6 (relay)	100 to 240V ac
1760-IA12XOW4I	12 (100 to 240V ac)	4 (relay)	100 to 240V ac
1760-IB12XOW6I	12 (24V dc)	6 (relay)	24V dc
1760-IB12XOB8	12 (24V dc)	8 (transistor)	24V dc
1760-OW2	-	2 (relay)	24V dc

Expansion modules connect directly to the Pico controller as shown below.

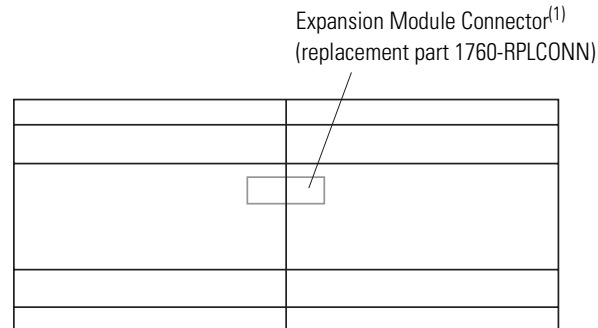

Pico Controller:
 1760-L18AWA-EX
 1760-L18BWB-EX
 1760-L18AWA-EXND
 1760-L18BWB-EXND
 1760-L18DWD-EX
 1760-L20BBB-EX
 1760-L20BBB-EXND

Expansion Module:
 1760-IA12XOW6I
 1760-IB12XOB8
 1760-IA12XOW4IF
 1760-IB12XOW6I
 1760-OW2

(1) Included with expansion module. Catalog Number is listed as a replacement part.

ATTENTION



Electrical isolation is provided between the Pico controller and the expansion module as follows:

- Basic Isolation: 400V ac (+10%)⁽¹⁾
- Reinforced Isolation 240V ac (+10%)⁽²⁾

The controller and expansion units may be destroyed if the potential between them exceeds the Basic Isolation value provided. This may cause your entire system or machine to malfunction.

(1) Basic Insulation - An insulation system which provides a minimal level of protection against electric shock up to a stated voltage level. Refer to EN 61131-2 for additional information.

(2) Reinforced Insulation - An insulation system comprised of basic and supplemental insulation. This provides protection against electric shock up to a stated voltage level and is tolerant of a single fault. Refer to EN 61131-2 for additional information.

TIP

The Pico controller and the expansion module can be of different voltage types.

Remote Processor

Remote Processor Features

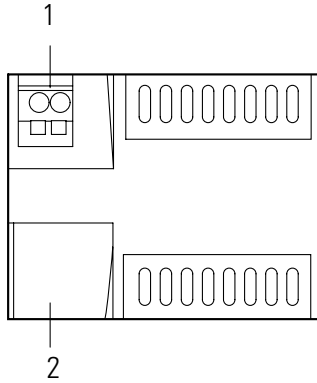

1. 24V dc Voltage supply
2. Interface Terminal (with cover) for connecting cable



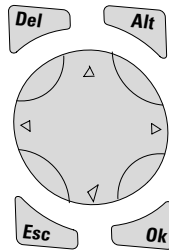

Operating Principles

Operating Buttons



Button	Function
Del	Delete object in the circuit diagram
Alt	Special functions in the circuit diagram
Cursor Buttons	Move cursor
	Select menu item
	Choose contact numbers, values, times, etc.
Ok	Next menu level, store your entry
Esc	Previous menu level, cancel your entry

Using Menus to Choose Values

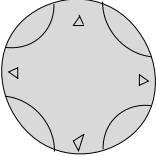
Press	To
 and  together	Show system menu
	<ul style="list-style-type: none"> • Go to next menu level. • Select menu item. • Store your entry.
	<ul style="list-style-type: none"> • Return to last menu level. • Cancel your entry since the last Ok.
	<ul style="list-style-type: none"> • Change menu item. • Change value. • Change position. <p>Cursor Button Set to P-Button Function (if enabled)</p> <ul style="list-style-type: none"> • Left Arrow = Input P1 • Right Arrow = Input P3 • Up Arrow = Input P2 • Down Arrow = Input P4

Selecting the Main and System Menus

1760-L12xxx Status Display

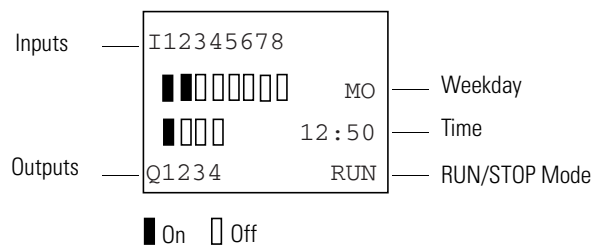

1760-L18xxx Status Display

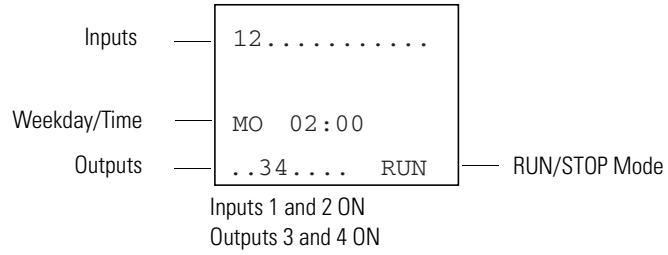

1760-L18xxx-EX and 1760-L20xxx Status Display for Expansion Module

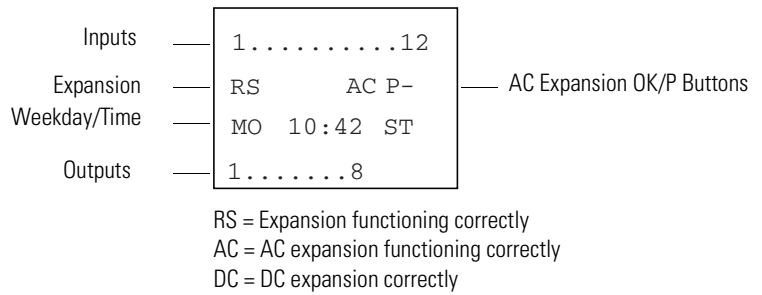

LED Indicators

Catalog numbers 1760-L12AWA-ND, 1760-L12BWB-ND, 1760-L18xxx, 1760-L20BBB-EXND, 1760-IA12XOW6I, 1760-IB12XOB8, 1760-IA12XOW4I and 1760-IB12XOW6I all feature an LED indicator on the front that shows the status of the incoming power as well as Run or Stop status.

LED Indicator Status	Indicates
LED OFF	No power
LED continuously lit	Power present, Stop mode
LED flashing	Power present, Run mode

Menu Structure

Main Menu Without Optional Password Protection

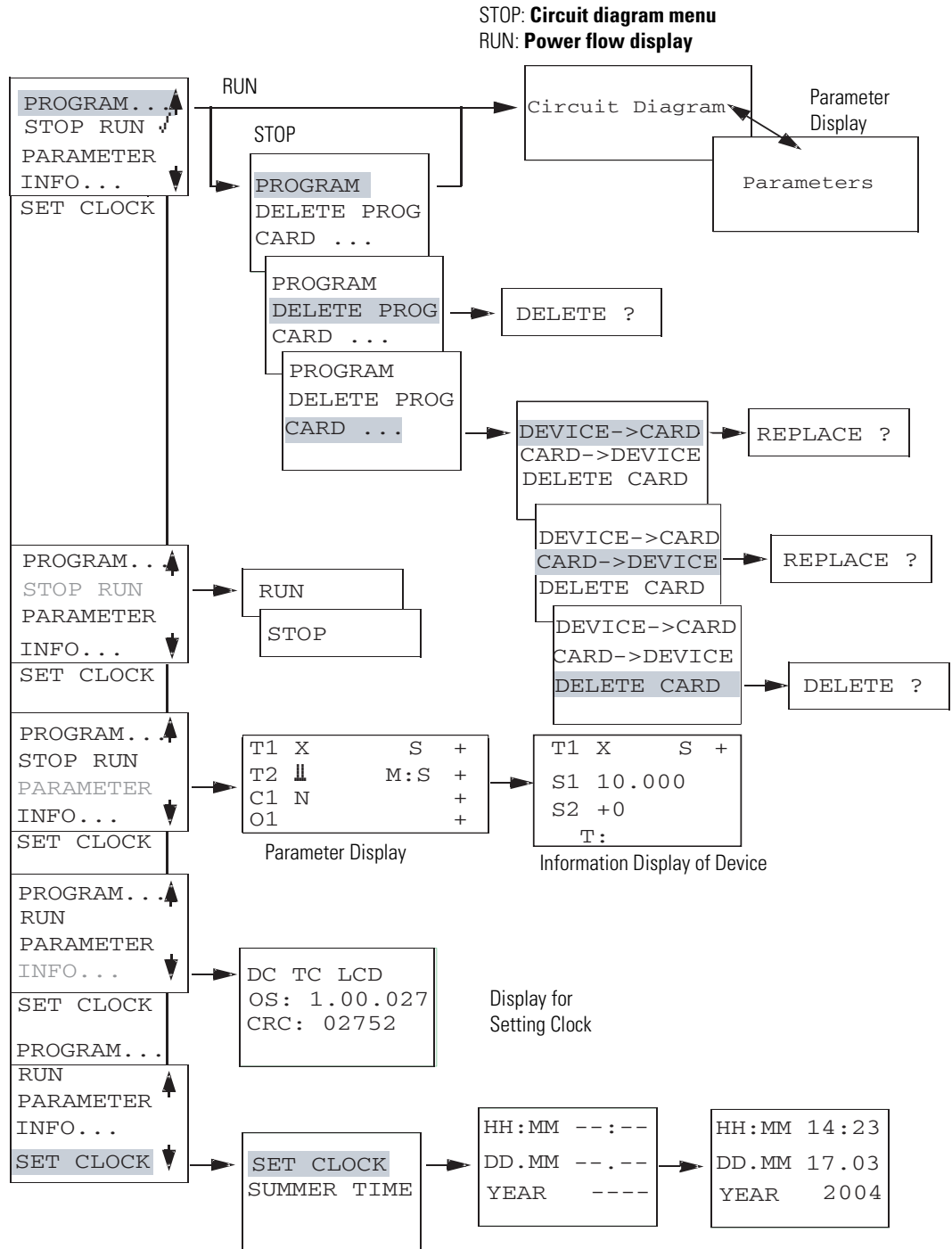

Main Menu Setting Summer Time

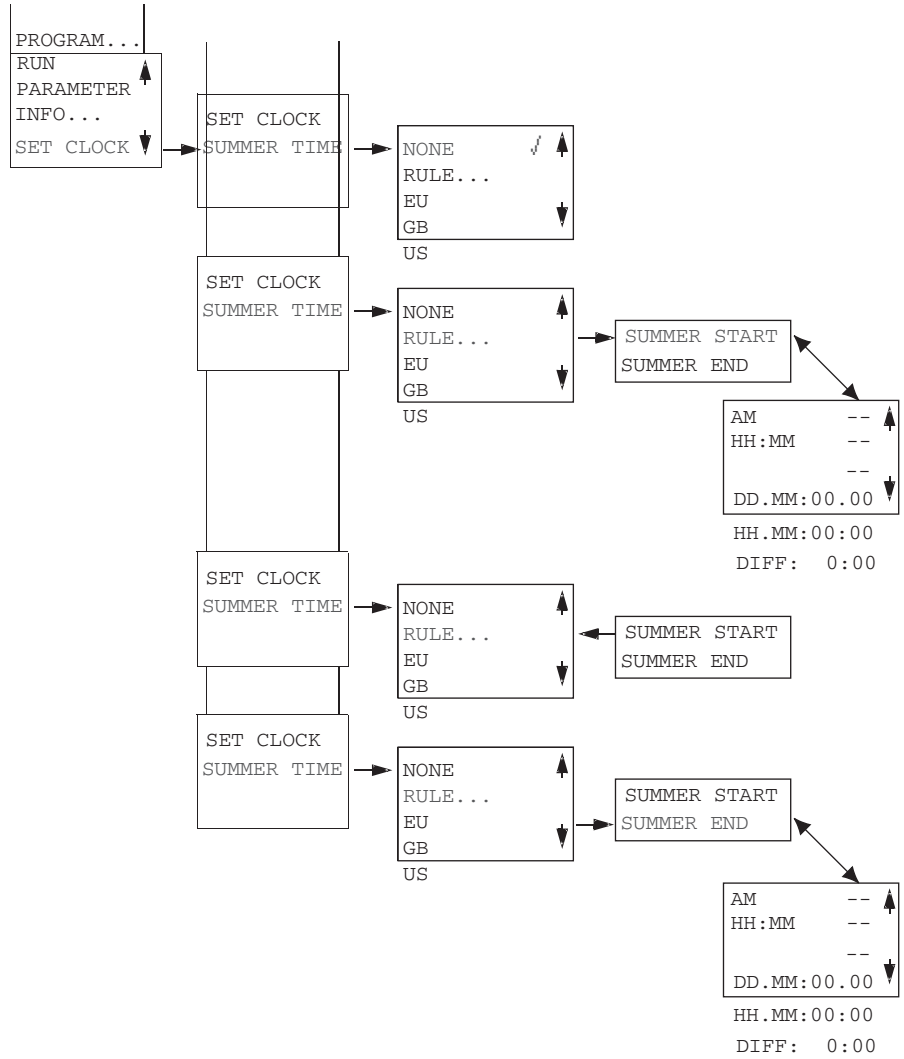

Main Menu with Password Protection

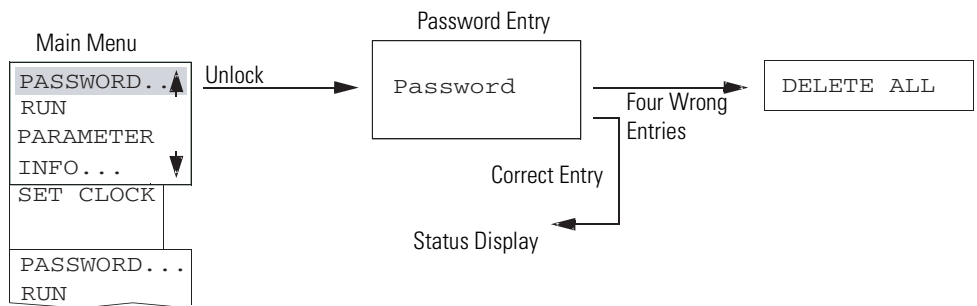

System Menu

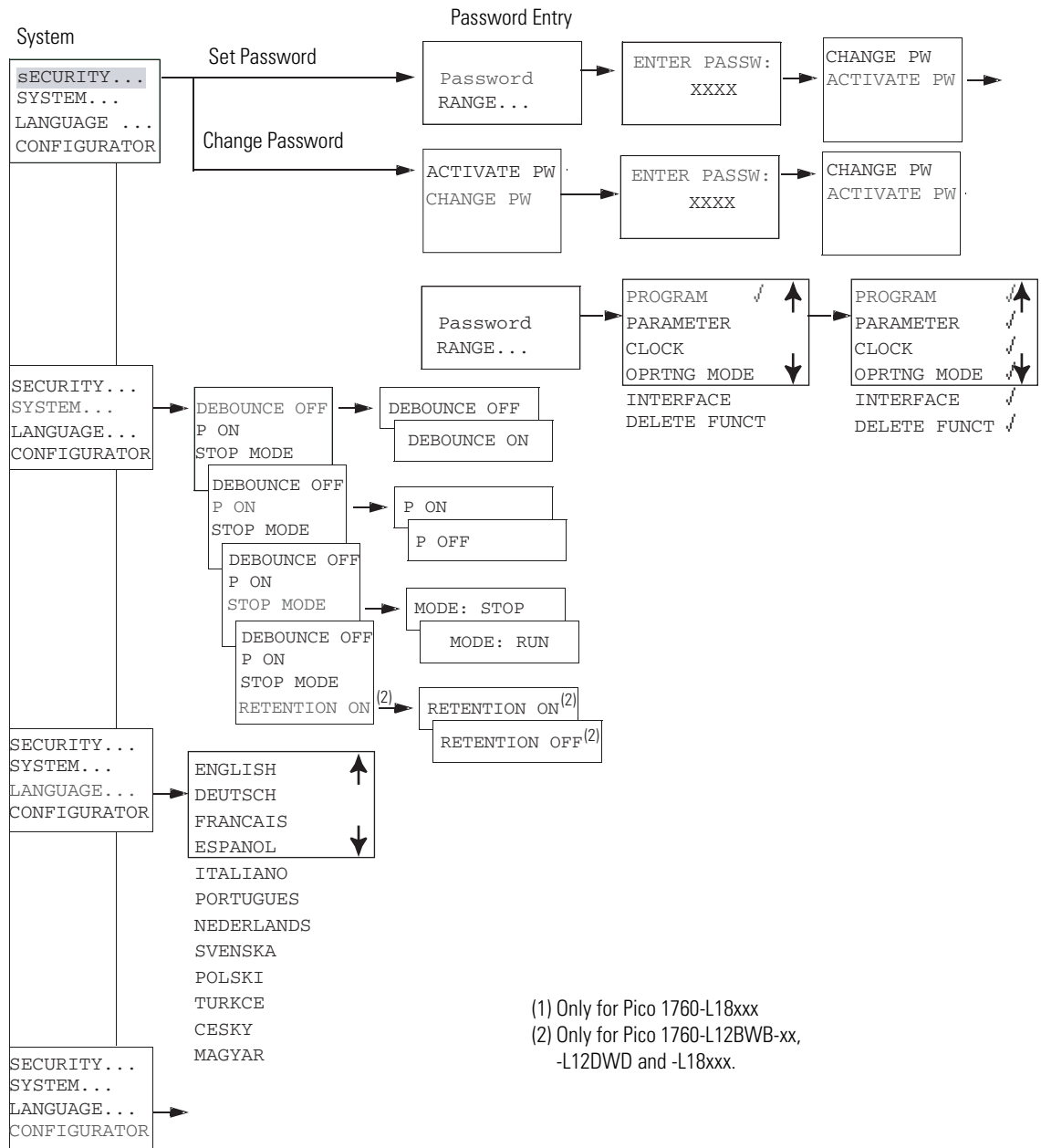

Selecting or Toggling Between Menu Items

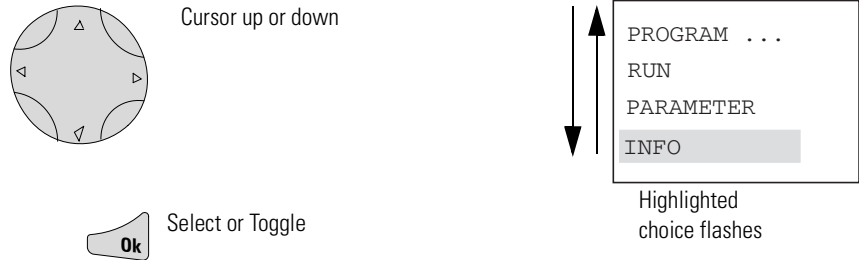

Cursor Display

There are two different cursor types: flashing block and flashing cursor.

HH:MM	█ 4:23
DD.MM	17.03
YEAR	2004

Full block navigation is shown as a flashing block:

- Move cursor with the left/right arrows
- In circuit diagram also with up/down arrows

HH:MM	14:23
DD.MM	17.03
YEAR	2004

Parameter change cursor flashes the selected parameter:

- Change position with left/right arrows
- Change values with up/down arrows

Flashing values/menus are highlighted in grey in this manual.

Setting Values

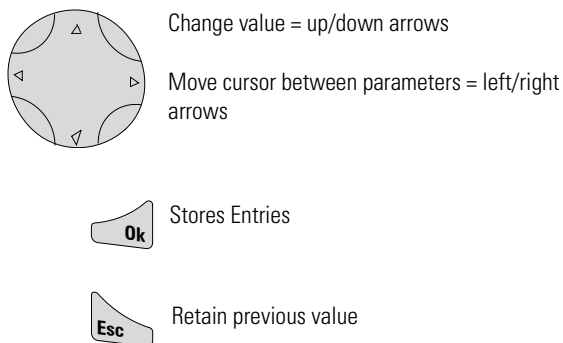

HH:MM	14:23
DD.MM	17.03
YEAR	2004

Left/right arrow moves the cursor between the day and time digits.
 Up/down arrow changes the value of the parameter.
 Up arrow = increment
 Down arrow = decrement

Installation

Pico is installed in the following order:

- connect devices together, if necessary
- Mount
- Use surge suppressors
- Wire the inputs
- Wire the outputs
- Connect incoming power

Prevent Electrical Shock

ATTENTION

Follow these guidelines when you handle the controller:



- Remove power before working on any of the wiring to Pico.
 - Touch a grounded object to discharge static potential.
 - Wear an approved wrist-strap grounding device.
 - If available, use a static-safe work station.
-

European Communities (EC) Directive Compliance

If this product has the CE mark it is approved for installation within the European Union and EEA regions. It has been designed and tested to meet the following directives.

EMC Directive

This product is tested to meet the Council Directive 89/336/EC Electromagnetic Compatibility (EMC) by applying the following standards, in whole or in part, documented in a technical construction file:

- EN 50081-1 EMC — Generic Emission Standard, Part 1 — Residential, Commercial, and Light Industry
- EN 50082-2 EMC — Generic Immunity Standard, Part 2 — Industrial Environment

This product is intended for use in an industrial environment.

Low Voltage Directive

This product is tested to meet Council Directive 73/23/EEC Low Voltage, by applying the safety requirements of EN 50178 Electric Equipment for Power Installations Equipment Requirements and Tests. For specific information required by EN 50178, see the appropriate sections in this publication, as well as the Allen-Bradley publication Industrial Automation Wiring and Grounding Guidelines For Noise Immunity, publication 1770-4.1.

This equipment is classified as open equipment and must be mounted in an enclosure during operation to provide safety protection.

Connect the Expansion Module

Connect the expansion module to the controller using the connector as shown below:

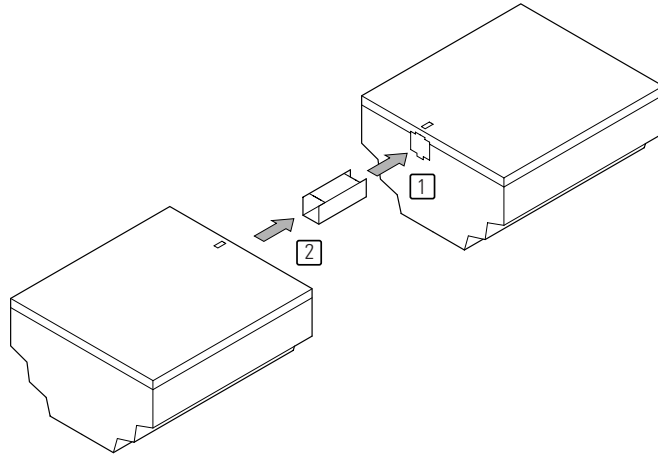

See Expansion Modules on page 1-4 for information on using the modules with your Pico controller.

Mount the Pico Controller

Install Pico in an enclosure, switch cabinet, or distribution board so that the power feed and terminal connections cannot be touched accidentally during operation.

Clip Pico onto a DIN rail or install directly onto a panel using the mounting feet. Pico can be mounted either vertically or horizontally.

TIP

When using a Pico expansion module, connect the expansion module and Pico controller together before mounting. See Connect the Expansion Module.

Minimum Spacing

Maintain spacing from enclosure walls, wireways, adjacent equipment, etc. Allow 3 cm (1.18 in.) of space on all sides for adequate ventilation, as shown:

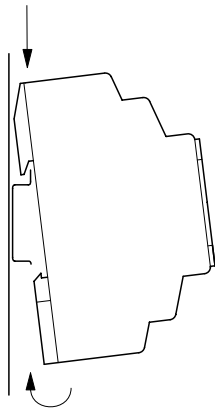
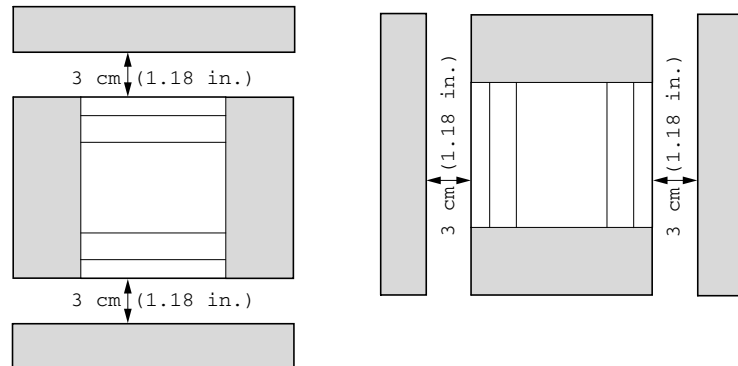

DIN Rail Mount

1. Mount your DIN rail. Make sure that the placement of the Pico unit on the DIN rail meets the recommended spacing requirements.
2. Hook the top slot over the DIN rail.
3. While pressing the Pico unit down against the top of the rail, snap the bottom of the unit into position. Ensure DIN latches are in the up (secured) position.

Pico can be mounted vertically on a DIN rail in the same manner.

Install on a Mounting Plate

To install the unit using mounting screws:

1. Snap the mounting feet in place.
2. Drill holes at the mounting feet positions, shown below.
3. Mount the controller.

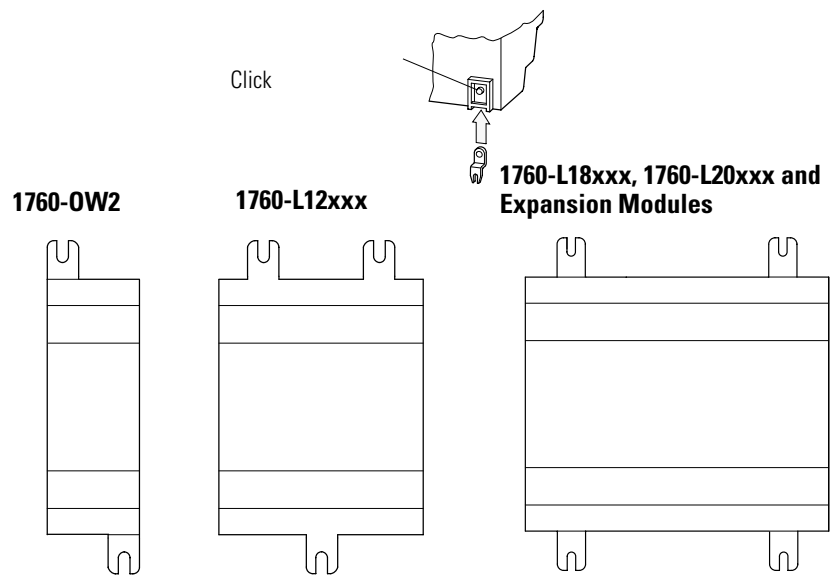

For mounting dimensions, see Dimensions on page A-14.

Install the Remote Processor

The remote processor is used for terminal mode operation of Pico controllers and I/O modules. The remote processor is used with either a Display or Display/Keypad Unit.

Remote Processor Terminal Operation

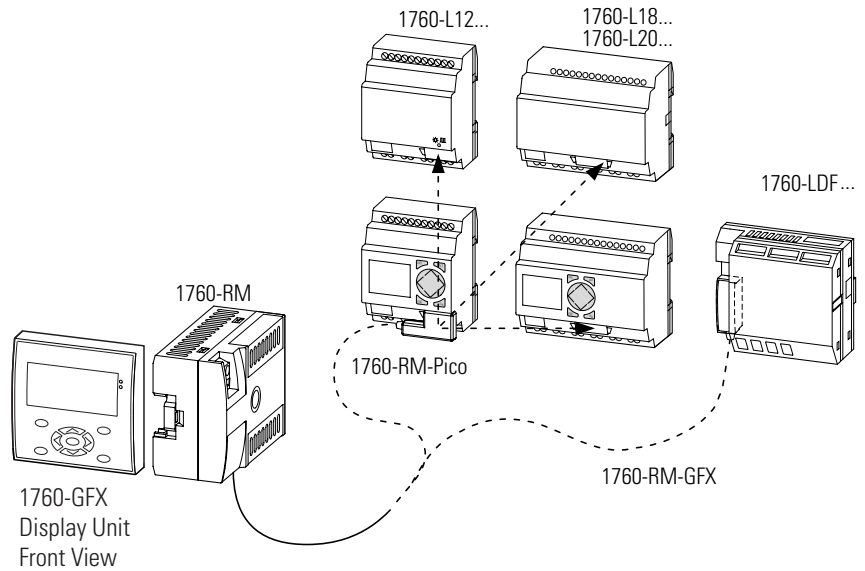

Flush Mount

Flush Mount the Display and Remote Processor

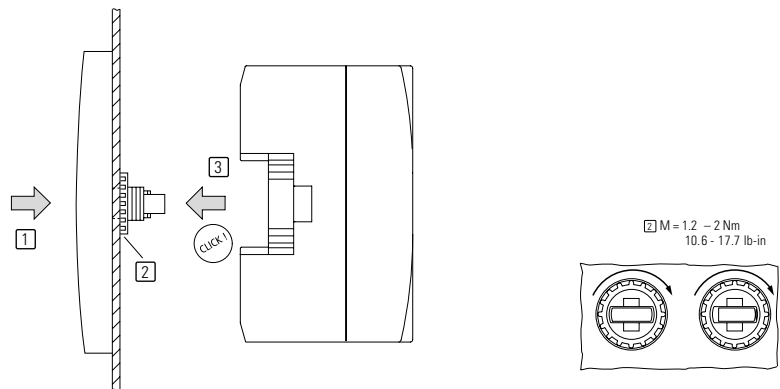

1. Insert the display unit through the mounting holes on the panel.
2. Attach the fixing rings.
3. Attach the processor unit.

Removal Procedure

Remove the Remote Processor

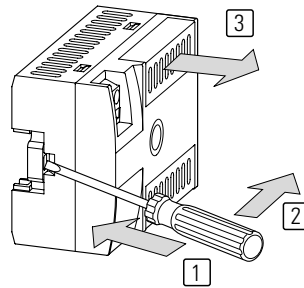

1760-RM

1. Insert the screwdriver into the mounting slide.
2. Push screwdriver to the right to open the slide.
3. Remove the processor unit from the display unit.
4. Loosen the fixing rings.
5. Remove the display unit from the panel.

Make Connections

Connect the Power Supply

Remote Processor Power Supply Connection

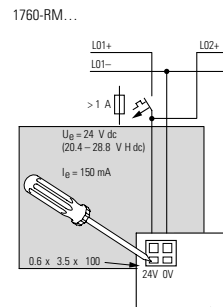

Connect the Serial Cable

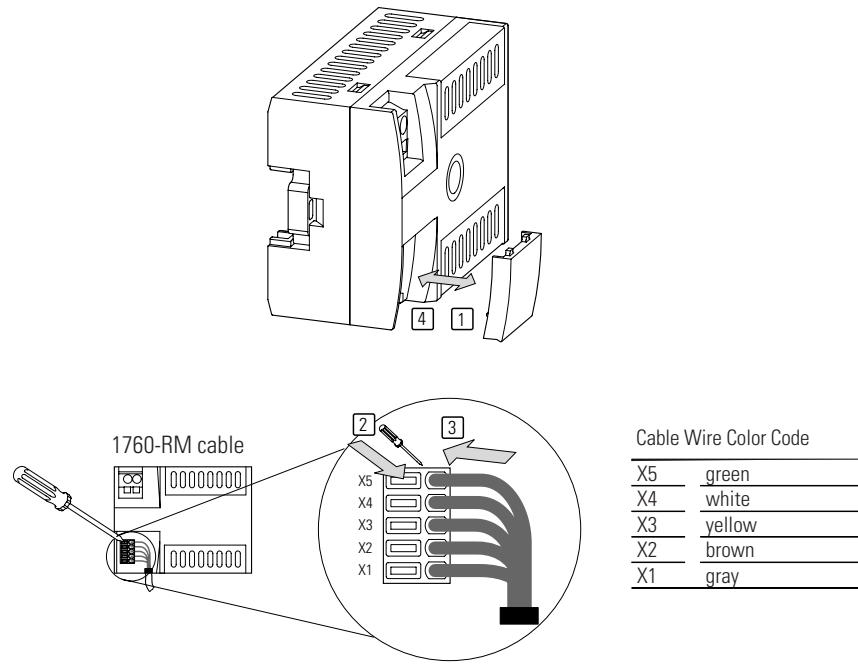

1. Remove the interface cover.
2. Using a screwdriver, push on the terminal latch.
3. Insert each wire into its designated terminal on the interface connector.
4. Replace the interface cover.

Plug the other end of the cable into the Pico controller or I/O module.

Wire Terminals

Required Tools

Slot-head screwdriver (width: 3.5 mm, torque: 0.57 to 0.79 Nm [5 to 7 in-lb])

Wire Size

- Solid
AWG 22 to AWG 12
- Stranded
AWG 22 to AWG 12

Connect the Incoming Power

For incoming power technical specifications, refer to Appendix A.

ATTENTION



ELECTRICAL SHOCK HAZARD

The memory module and PC-cable socket are at the potential of L2. There is a danger of electric shock if L2 is not grounded. Do not make contact with electrical components under the socket cover.

TIP

A brief current surge is produced when powering on the unit for the first time. Do not switch the unit using reed contacts, since these may burn or melt.

1760-L12AWA, -L12AWA-NC, -L12AWA-ND, -L18AWA,

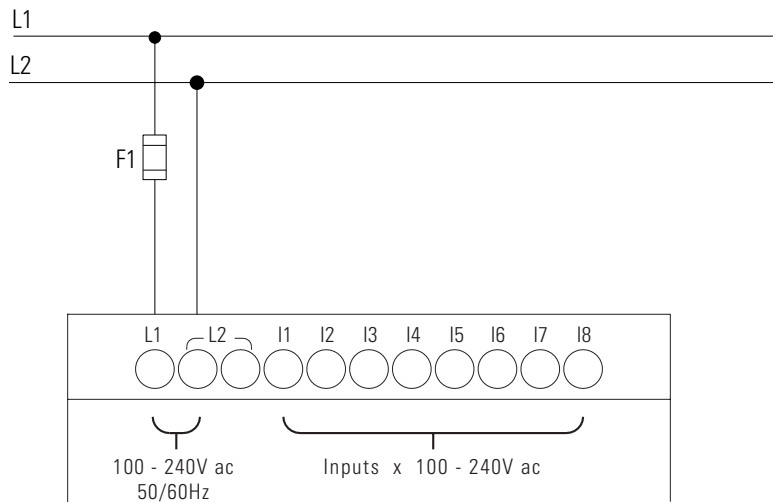

1760-IA12XOW6I Expansion Module

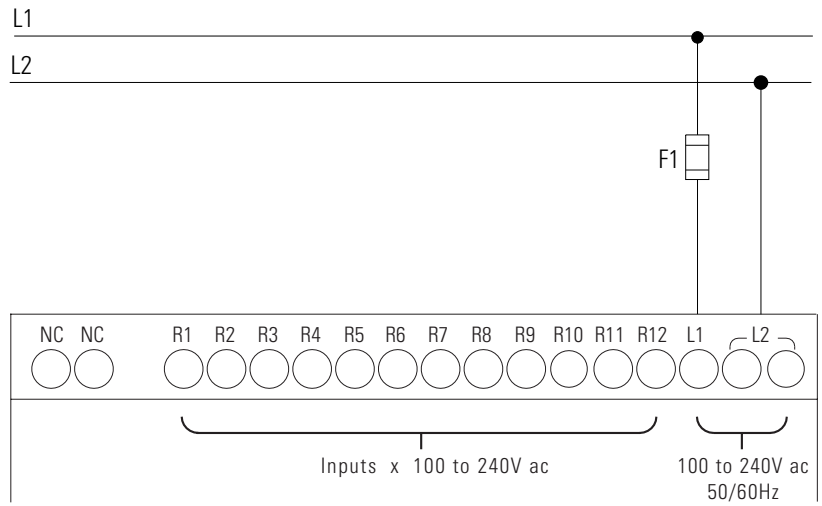

1760-L12BWB, -L12BWB-NC, -L12BWB-ND, -L18BWB-EX

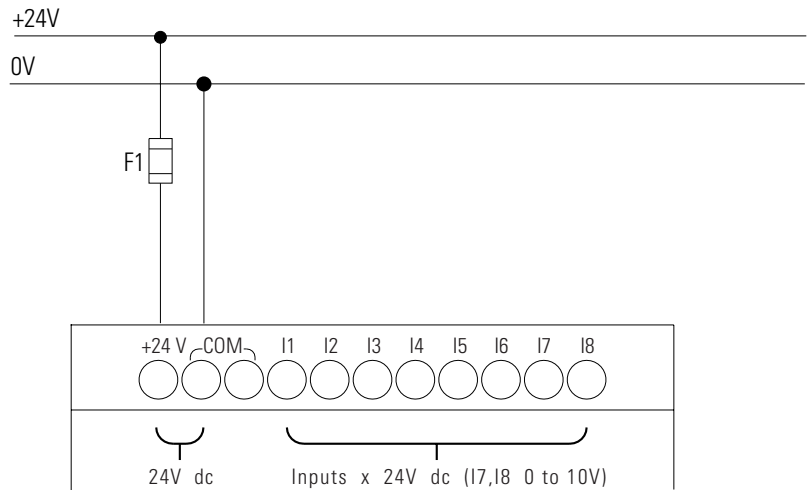

1760-IB12XOB8 Expansion Module

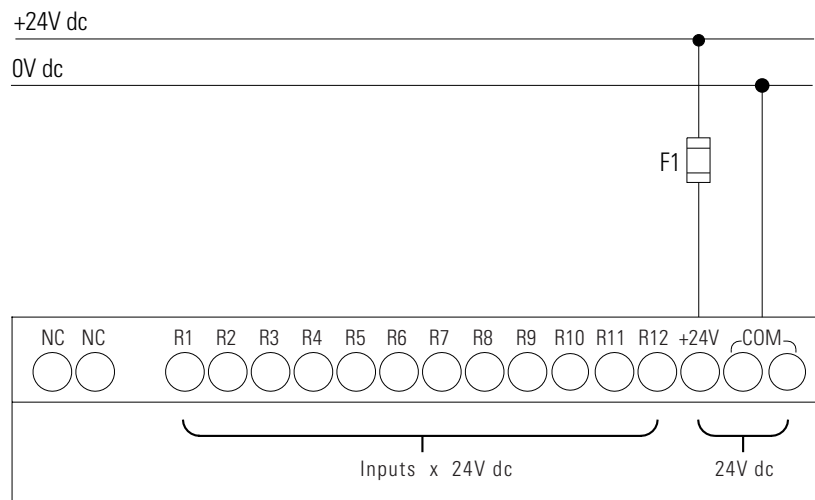

1760-L12DWD

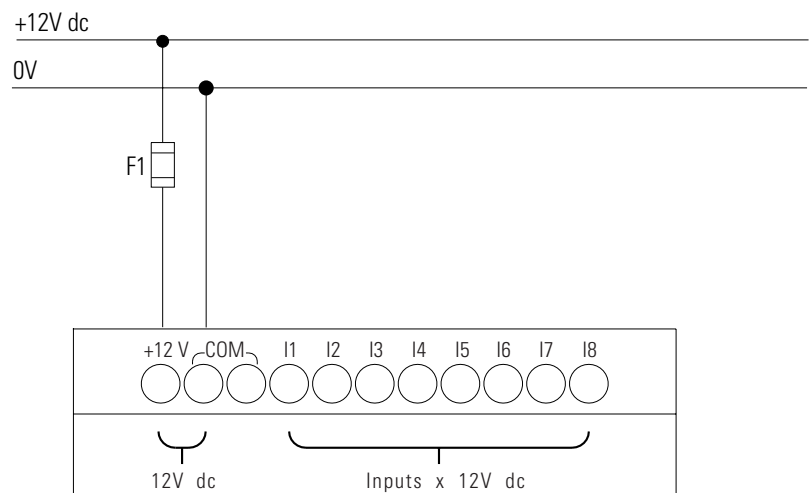

The dc controllers are protected against polarity reversal. To ensure that the unit works correctly, ensure that the polarity of each terminal is correct.

Wiring Protection

Both AC and DC versions require wiring protection (F1) rated for at least 1 A (slow).

When the unit is powered on for the first time, the power supply circuit draws a larger surge current than usual. Use an appropriate device for switching on the incoming power and do not use any reed relay contacts or proximity switches.

Use Surge Suppressors

Inductive load devices, such as motor starters and solenoids, require the use of some type of surge suppression to protect and extend the operating life of the controller's output contacts. Switching inductive loads without surge suppression can SIGNIFICANTLY reduce the life expectancy of relay contacts. By adding a suppression device directly across the coil of an inductive device, you prolong the life of the output or relay contacts. You also reduce the effects of voltage transients and electrical noise from radiating into adjacent systems.

The following diagram shows an output with a suppression device. We recommend that you locate the suppression device as close as possible to the load device.

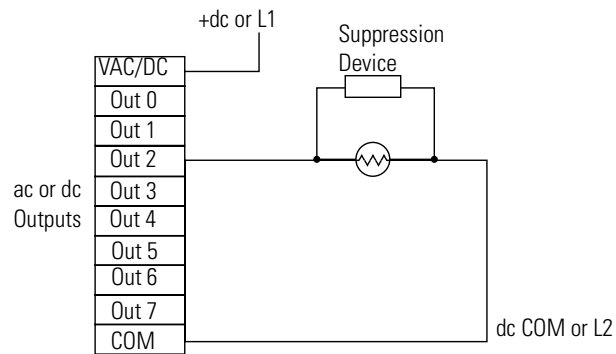

If the outputs are dc, we recommend that you use an 1N4004 diode for surge suppression, as shown below.

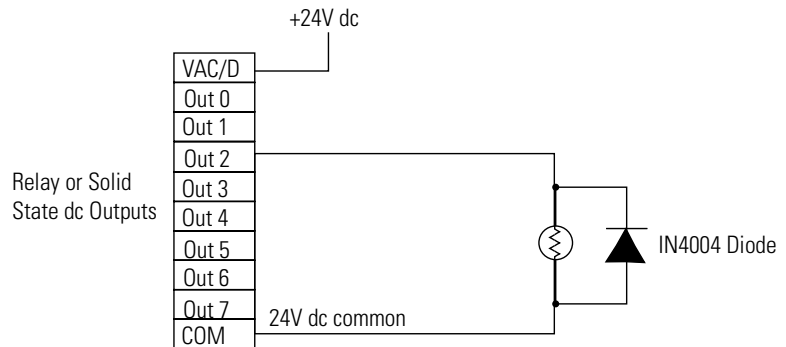

Suitable surge suppression methods for inductive ac load devices include a varistor, an RC network, or an Allen-Bradley surge suppressor, all shown below. These components must be appropriately rated to suppress the switching transient characteristic of the particular inductive device. See the table on page 2-14 for recommended suppressors.

Surge Suppression for Inductive ac Load Devices

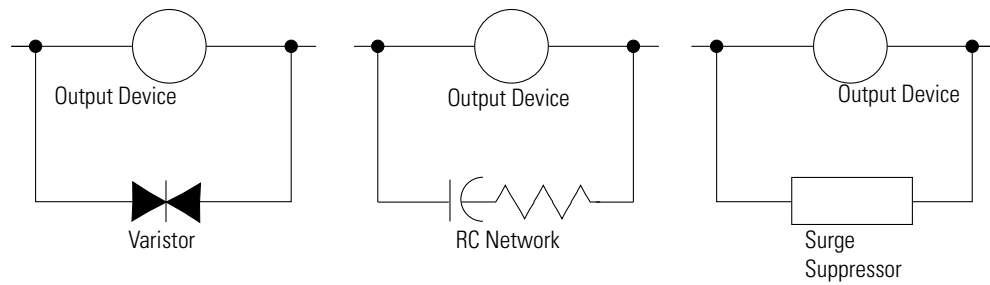

For inductive dc load devices, a diode is suitable. A 1N4004 diode is acceptable for most applications. A surge suppressor can also be used. See the table on page 2-14 for recommended suppressors.

As shown in the illustration below, these surge suppression circuits connect directly across the load device.

Surge Suppression for Inductive dc Load Devices

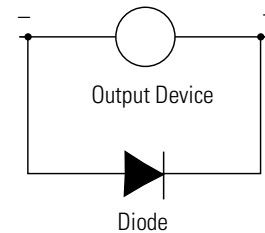

(A surge suppressor can also be used.)

Recommended Surge Suppressors

Use the Allen-Bradley surge suppressors shown in the following table for use with relays, contactors, and starters.

Suppressor Device	Coil Voltage	Catalog Number
Bulletin 509 Motor Starter	120V ac	599-K04
Bulletin 509 Motor Starter	240V ac	599-KA04
Bulletin 100 Contactor	120V ac	199-FSMA1
Bulletin 100 Contactor	240V ac	199-FSMA2
Bulletin 709 Motor Starter	120V ac	1401-N10
Bulletin 700 Type R, RM Relays	ac coil	None Required
Bulletin 700 Type R Relay	12V dc	700-N22
Bulletin 700 Type RM Relay	12V dc	700-N28
Bulletin 700 Type R Relay	24V dc	700-N10
Bulletin 700 Type RM Relay	24V dc	700-N13
Bulletin 700 Type R Relay	48V dc	700-N16
Bulletin 700 Type RM Relay	48V dc	700-N17
Bulletin 700 Type R Relay	115-125V dc	700-N11
Bulletin 700 Type RM Relay	115-125V dc	700-N14
Bulletin 700 Type R Relay	230-250V dc	700-N12
Bulletin 700 Type RM Relay	230-250V dc	700-N15
Bulletin 700 Type N, P, or PK Relay	150V max, ac or DC	700-N24
Miscellaneous electromagnetic devices limited to 35 sealed VA	150V max, ac or DC	700-N24

Connect the Inputs

Pico inputs switch electronically. Once you have connected a device via an input terminal, you can reuse it as a relay contact in your program as often as you like.

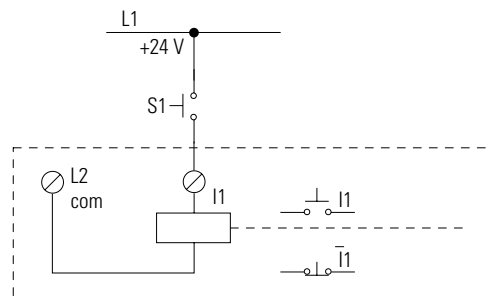

Connect devices such as buttons or switches to Pico input terminals.

Connecting AC Inputs

ATTENTION



For Pico controllers with ac inputs, connect the inputs to the same phase as the power feed L1, in accordance with VDE, IEC, UL and CSA safety regulations. Otherwise, Pico may not detect the switching level or, it may be damaged by excess voltage.

Input	Specification
Input Signal Voltage Range	OFF signal: 0 to 40V ac
	ON signal: 79V to 264V ac
Input Current	I1 to I6, I9 to I12, R1 to R12: 0.25 mA at 120V ac, 0.5 mA at 240V ac
	I7 and I8: 4 mA at 120V ac, 6 mA at 240V ac,

Example Using 1760-L12AWA

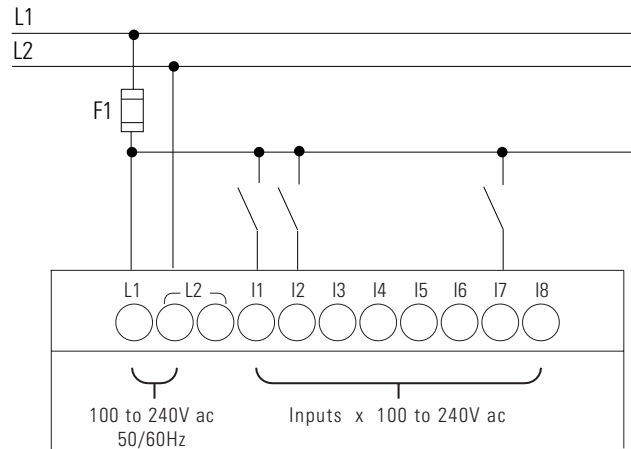

Example Using 1760-IA12XOW6I

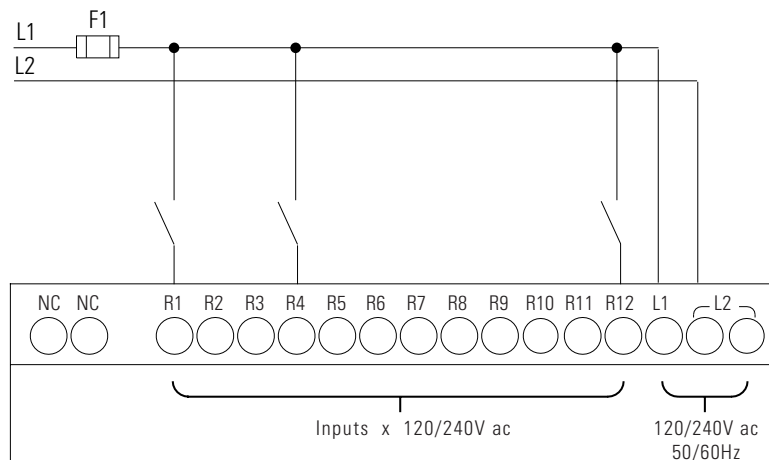

Wire Lengths

Severe electromagnetic interference to wires can cause inputs to signal 1 without the proper signal being applied. Observe the following maximum cable lengths:

- I1 to I6, I9 to I12, R1 to R12: 40m (130 ft) without additional circuits
- I7 and I8: 100m (330 ft) without additional circuits

ATTENTION



Do not use reed relay contacts on I7 or I8. These may burn or melt due to the high current of I7 and I8.

Two-wire proximity sensors have a residual off-state leakage current. If this residual current is too high, the input may indicate the input is ON when the device is actually off.

Use inputs I7 and I8 for these types of input devices. If more inputs are required, use a bleeder resistor or bleeder capacitor for inputs I1 through I6, and I9 through I12.

Increase the Input Current

Use the following input circuit for electrical noise immunity and when using two-wire proximity switches:

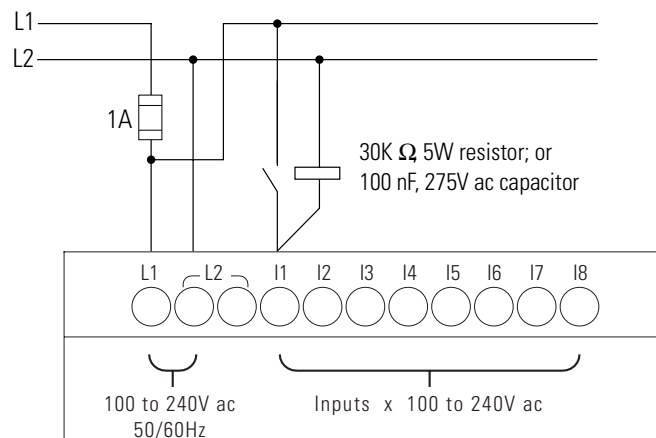

When using a 100 nF capacitor, the drop-off time of the input increases by 66.6 ms at 60 Hz (80 ms at 50 Hz). Also, a capacitor increases the amount of current seen by the input device. Do not use a bleeder capacitor in conjunction with reed switches.

To limit the current to 400 mA, connect a 1K Ω resistor in series upstream from the circuit as shown.

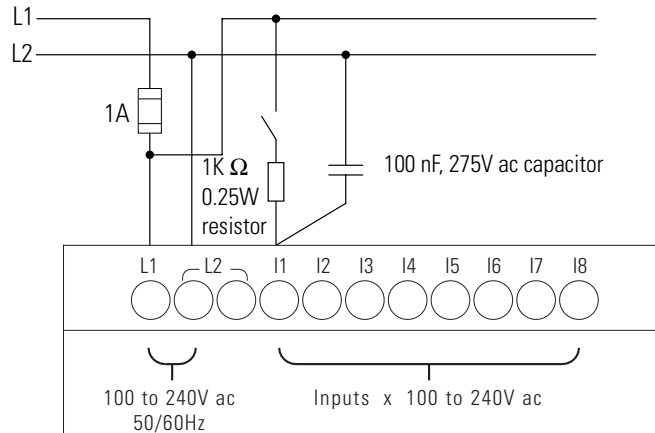

Connect 24 V dc Inputs

Use input terminals I1 to I8 (or I12 for 18-point Pico) to connect push-buttons, switches, or 3- or 4-wire proximity switches. Given the high off-state leakage current, do not use 2-wire proximity switches.

Input	Specification
Input Signal Voltage Range	OFF signal: 0 to 5V dc
	ON signal: 15V to 28.8V dc
Input Current	I1 to I6, I9 to I12, R1 to R12: 3.3 mA at 24V dc
	I7 and I8: 2.2 mA at 24V dc

Example Using 1760-L12BWB-xx

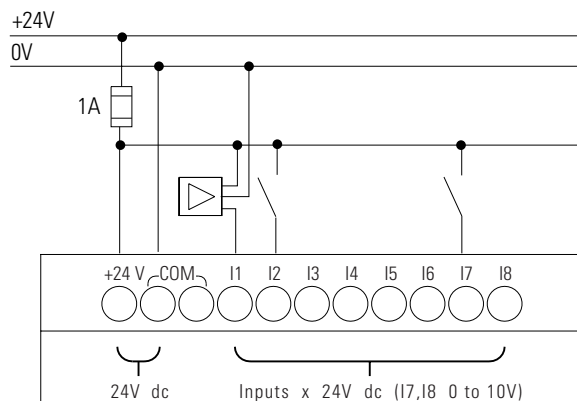

Example Using 1760-IB12X0B8

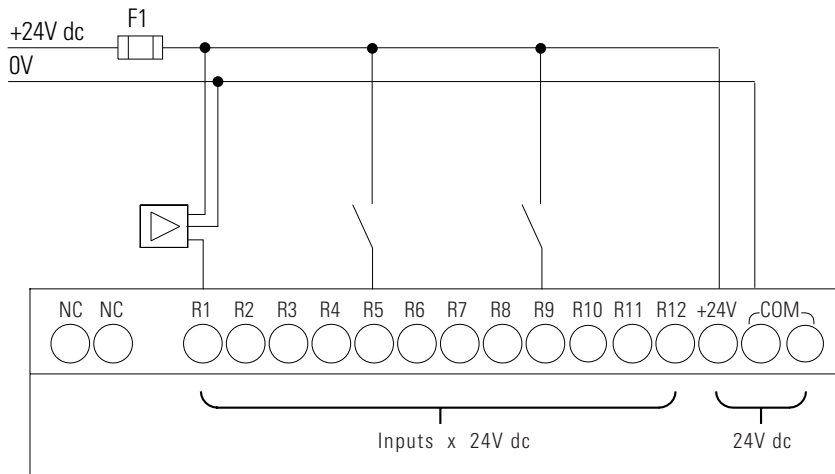

Connect 12 V dc Inputs

Use input terminals I1 to I8 to connect push-buttons, switches, or 3 or 4-wire proximity switches. Given the high off-state leakage current, do not use 2-wire proximity switches.

Input	Specification
Input Signal Voltage Range	OFF signal: 0 to 4V dc
	ON signal: 8V to 15.6V dc
Input Current	I1 to I6, I9 and I10: 3.3 mA at 12V dc
	I7 and I8, I11 and I12: 1.1 mA at 12V dc

Example Using 1760-L12DWD

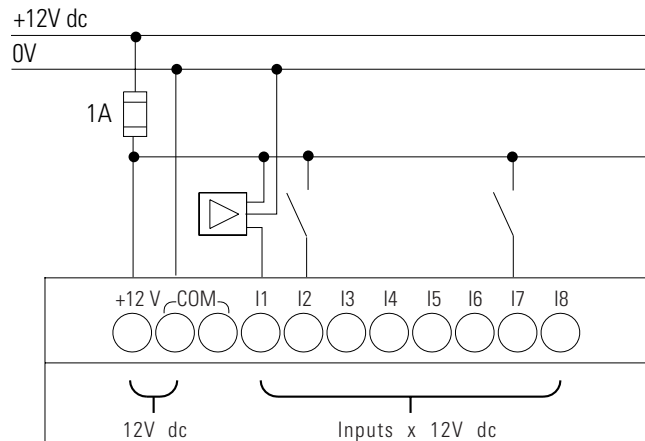

Connect Analog Inputs (1760-LxxBWB-xx or 1760-LxxDWD only)

Inputs I7 and I8, and if present I11 and I12, can also be used to connect analog devices ranging from 0 to 10V dc.

ATTENTION

Analog signals are more sensitive to interference than digital signals. Consequently, more care must be taken when routing and connecting the signal lines. Route the analog wiring:

- away from power lines, load lines and other sources of electrical noise such as hard-contact switches, relays, and AC motor drives
- away from sources of radiated heat

Incorrect switching states may occur if the analog wiring is not installed correctly.

Use shielded, twisted-pair cables to prevent interference with the analog signals. For short cable lengths, ground the shield at both ends with a large contact area. If the cable length exceeds 30m (98.4 ft), grounding at both ends can result in ground loops between the two grounding points and thus to the interference of analog signals. In this case, only ground the cable at one end. Do not route signal lines parallel to power cables.

Connect inductive loads to be switched via Pico outputs to a separate power feed, or use a suppressor circuit for motors and valves. If loads such as motors, solenoid valves or contactors are operated via the same power feed, switching may result in interference on the analog input signals.

The following four circuits illustrate application examples for analog value processing.

Ensure that the reference potential is connected. Connect the 0V of the power supply unit for the different setpoint potentiometers and sensors to the 0V of the power feed.

Setpoint Potentiometers

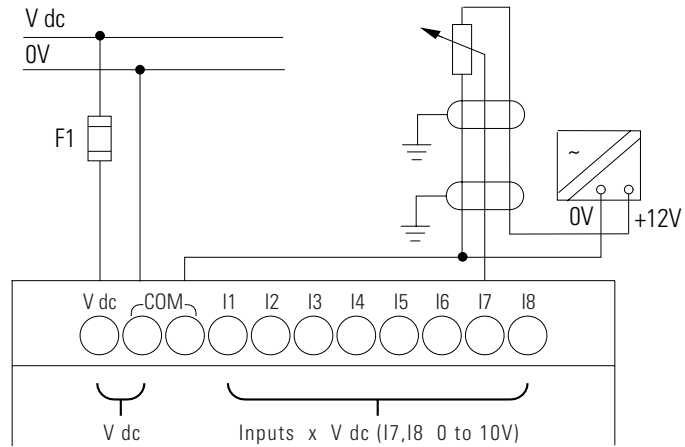

V dc = 12Vdc for 1760-L12DWD
 V dc = 24V dc for 1760-LxxBWB-xx

Use a potentiometer with a resistance of less than or equal to 1K Ω e.g. 1K Ω 0.25W.

Light Intensity Sensors

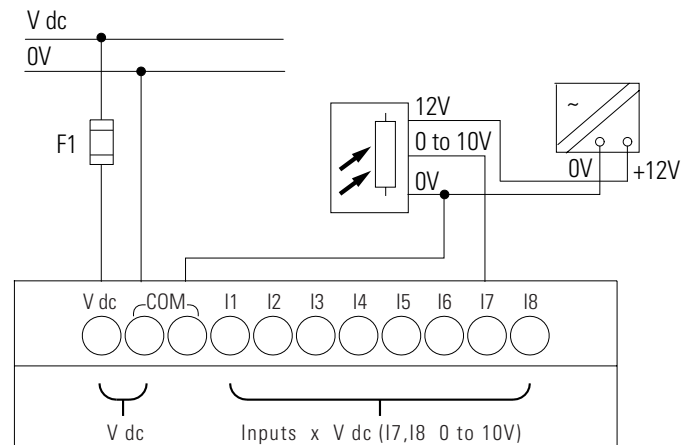

V dc = 12Vdc for 1760-L12DWD
 V dc = 24V dc for 1760-LxxBWB-xx

Temperature Sensors

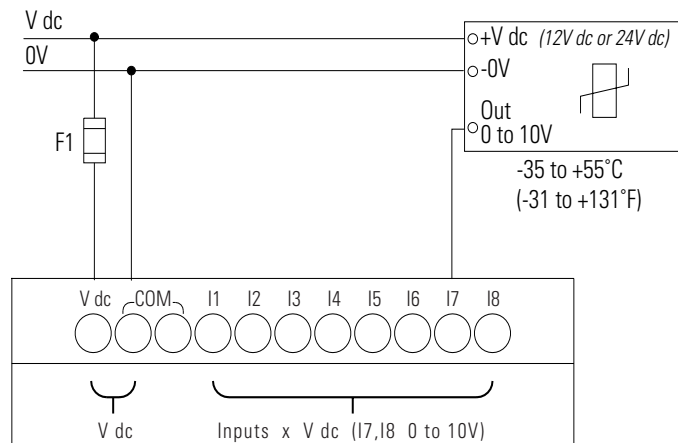

V dc = 12Vdc for 1760-L12DWD
 V dc = 24V dc for 1760-LxxBWB-xx

20 mA Sensors

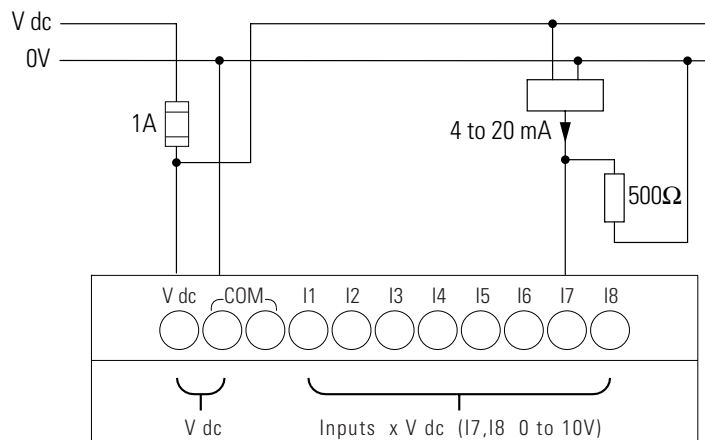

V dc = 12Vdc for 1760-L12DWD
 V dc = 24V dc for 1760-LxxBWB-xx

Connect 4 to 20 mA (0 to 20 mA) sensors using an external 500Ω resistor, as shown above. The resultant impedance to the sensor is approximately 478Ω

The following values result (Based on $V = R \times I = 478\Omega \times 10 \text{ mA} = 4.8\text{V dc}$):

- 4 mA = 1.9V dc
- 10 mA = 4.8V dc
- 20 mA = 9.5V dc

Connect Outputs

The Q output terminals function as isolated contacts, as shown below.

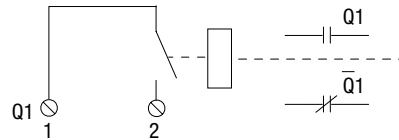

Outputs are controlled via the corresponding output relays:

- Q1 to Q4
- Q1 to Q8
- S1 to S6
- S1 to S8

You can use the signal states of the output relays as make or break contacts in the Pico program to provide additional logic conditions.

The relay or transistor outputs are used to switch loads such as fluorescent tubes, filament bulbs, contactors, relays or motors. Check the technical thresholds and output data before installing such devices (see Relay Outputs on page A-10).

Connect Relay Outputs

1760-L12AWA-xx, 1760-L12BWB-xx and 1760-L12DWD

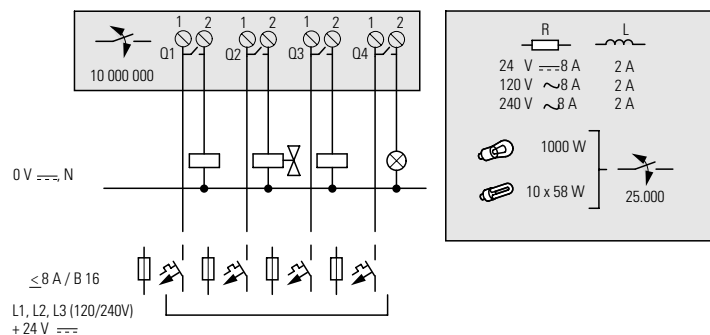

1760-L18AWA-xx and 1760-L18BWB-EX

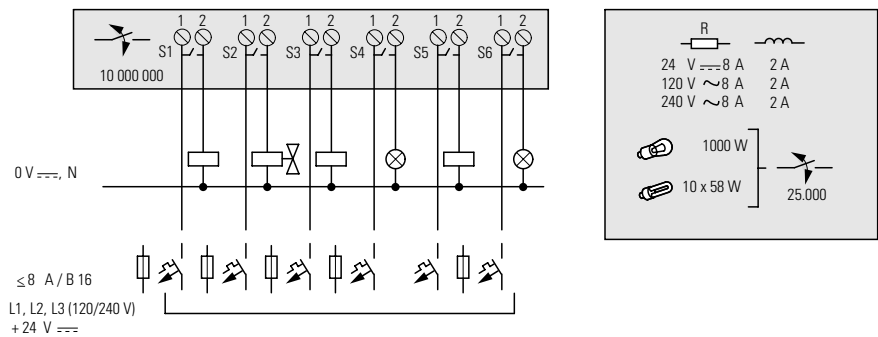

1760-IA12XOW6I

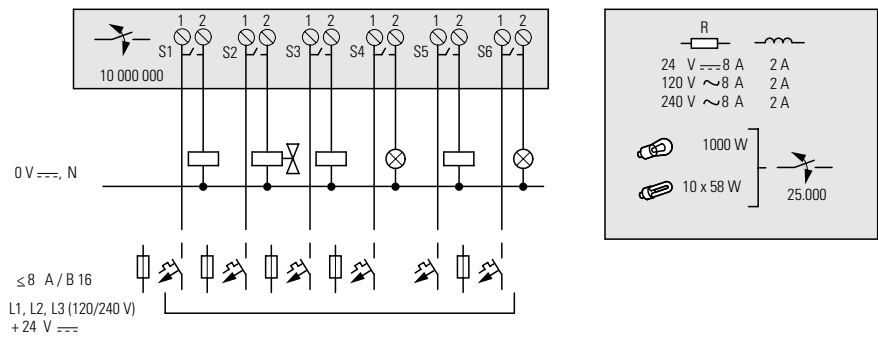

1760-OW2

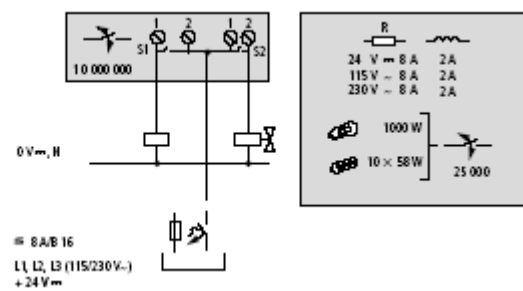

Unlike inputs, you can connect different phases to the outputs.

ATTENTION



Do not exceed the maximum voltage of 250V ac on a relay contact.

If the voltage exceeds this threshold, arcing may occur at the contact, resulting in damage to the device or to a connected load.

Connect Transistor Outputs 1760-lxxx

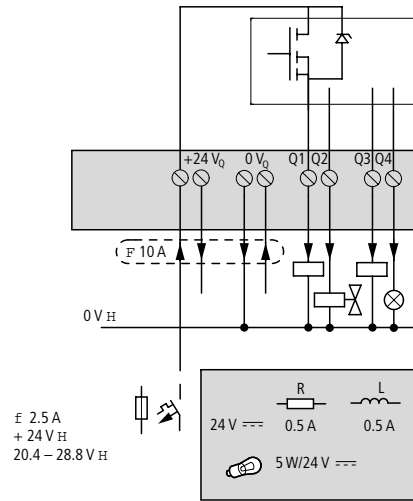

1760-lxxx

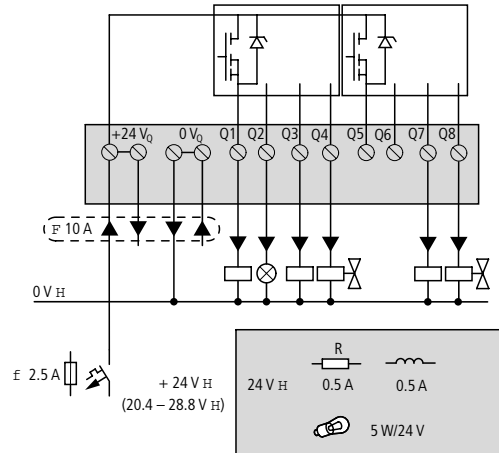

1760-IB12X0B8

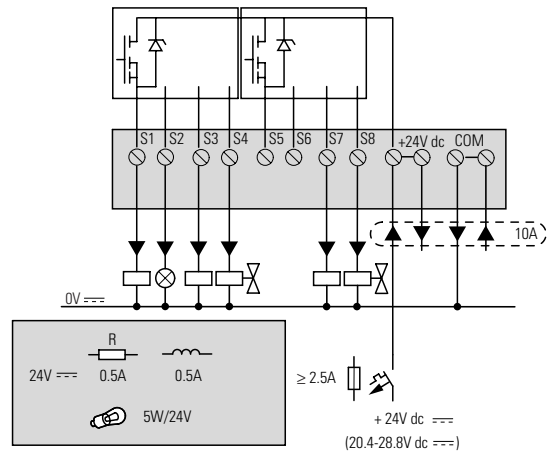

Parallel Connection

Up to four outputs can be connected in parallel in order to increase the load current. The output current will increase to a maximum of 2A.

ATTENTION



Outputs may only be connected in parallel within a group (S1 to S4) or (S5 to S8) such as (S1 and S3) or (S5, S7 and S8). Outputs connected in parallel must be switched ON and OFF at the same time.

Switch Inductive Loads

ATTENTION



Observe the following when switching off inductive loads:

Suppressed inductive loads cause less interference in the entire electrical system. For optimum suppression, the suppressor circuits are best connected directly to the inductive load. See Use Surge Suppressors on page 2-12.

If inductive loads are not suppressed, only one inductive load should be switched off at any one time to prevent the output transistors from overheating. If, in the event of an emergency stop, the +24V dc power supply is to be switched off by means of a contact, and this would mean switching off more than one controlled output with an inductive load, then you must provide suppressor circuits for these loads. See the following diagrams.

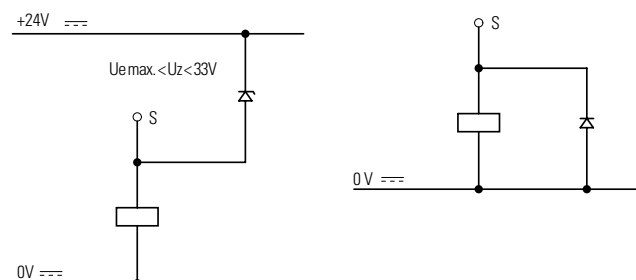

Short Circuit and Overload Behavior

If a short circuit or overload occurs on a transistor output, this output will switch off. The output will switch on up to maximum temperature after the cooling time has elapsed. This time depends on the ambient temperature and the current involved. If the fault condition persists, the output will continue to switch off and on until the fault is corrected or until the power supply is switched off.

For information on using the 1760-IB12XOB8 expansion module to monitor outputs for a fault, see Monitor for Short Circuit or Overload on page 9-4.

Commission the Pico

Power On Unit

Before powering up Pico, check that you have connected the power supply terminals and inputs correctly.

12V dc version:

- +12V terminal: +12V dc voltage
- COM terminal: 0V voltage
- terminals I1 to I8: actuation via +12V dc

24V dc version:

- +24V terminal: +24V dc voltage
- COM terminal: 0V voltage
- terminals I1 to I12, R1 to R12: actuation via +24V dc

100 to 240V ac version:

- terminal L1: phase conductor L1
- terminal L2: neutral conductor L2 (grounded)
- terminals I1 to I12, R1 to R12: actuation via phase conductor L1

ATTENTION

If you have already installed Pico into a system, ensure that the working area of all connected devices is secure. Advise all personnel of start-up to avoid injury in the event of unexpected operation.

Set the Menu Language

When you power-up Pico for the first time, you are asked to select the menu language.

Use the up and down cursor buttons to select a language. Definitions of the language abbreviations are shown below.

Language	LCD display	Abbreviaton
English	ENGLISH	GB
German	DEUTSCH	D
French	FRANCAIS	F
Spanish	ESPANOL	E
Italian	ITALIANO	I
Portuguese	PORTUGUES	–
Dutch	NEDERLANDS	–
Swedish	SVENSKA	–
Polish	POLSKI	–
Turkish	TURKCE	–
Czech	CESKY	–
Hungarian	MAGYAR	–

Press Ok to confirm your choice or press Esc to exit the menu. The unit then switches to the status display. You can also change the language setting at a later date, see Chapter 6 for more information.

If you do not set the language, Pico displays this menu and waits for you to select a language every time the unit is powered up.

ENGLISH	↑
DEUTSCH	
FRANCAIS	
ESPANOL	↓
ITALIANO	
PORTUGUES	
NEDERLANDS	
SVENSKA	
POLSKI	
TURKCE	
CESKY	
MAGYAR	

Modes of Operation

Pico has two operating modes: Run and Stop.

In Run mode, the unit continuously processes a stored program or circuit diagram until you select Stop or disconnect the power. The circuit diagram, parameters, and settings are retained in the event of a power failure. If the back-up time has elapsed after a power failure, you will need to reset the real-time clock. Circuit diagram entry is only possible in Stop mode.

ATTENTION

In Run mode, Pico immediately runs the circuit diagram saved in the unit when the incoming power is turned on. This happens unless Stop mode was set as start-up mode. In Run mode, outputs are activated according to the program.

In models with an LCD display, a circuit diagram inside an installed memory module is not run automatically. The circuit diagram must first be transferred from the memory module to the unit.

In Run mode, the 1760-L12xxx-ND and 1760-L18xxx-xxND load the circuit diagram from the memory module automatically and run it immediately.

Create a Circuit Diagram (Program)

The following small circuit diagram example takes you step-by-step through programming your first Pico circuit diagram. This example demonstrates most of the basic programming rules.

As with conventional wiring, you use contacts and relays in the Pico circuit diagram. With Pico, however, you no longer have to connect components individually. With the push of a few buttons, the Pico circuit diagram produces all the wiring. All you have to do is connect any switches, sensors, lamps or contactors you wish to use.

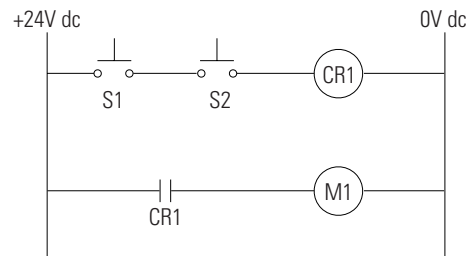

In the following example, Pico carries out all the wiring and performs the tasks of the circuit diagram shown above.

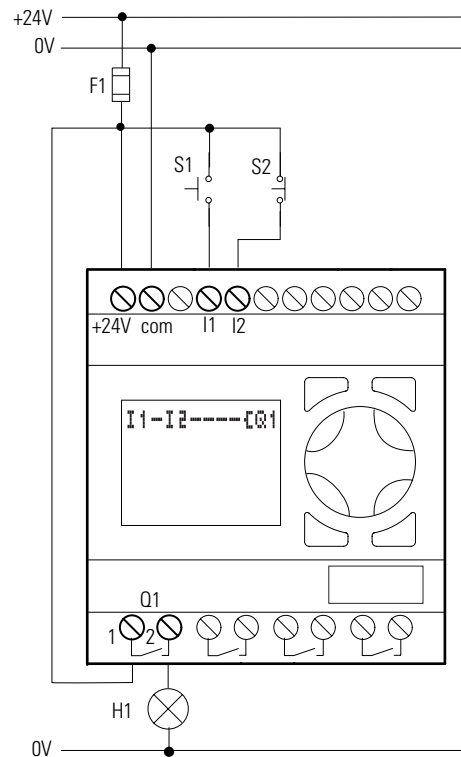

Start Point: Status Display

When you power up the unit, it opens the status display immediately to show the state of the inputs and outputs. It also indicates whether Pico is already running a program.

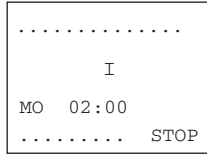

Press Ok to switch to the main menu. If there is an expansion module installed, the expansion module status screen is displayed. Press Ok again to switch to the main menu.

You can then press Ok to move forward to the next menu level or **Esc** to go back one level. Ok has two other functions:

Expansion Module Status Screen

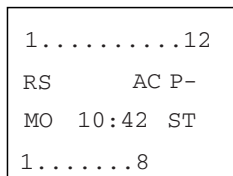

- Press Ok to save modified settings.
- Press Ok to insert and modify contacts and relay coils. In this case, Pico must be in Stop mode.

Press Ok two times (3 times with an expansion module installed) to enter the circuit diagram display from the status display(s). This is where you create the circuit diagram.

Circuit Diagram Display



The circuit diagram display is currently empty. The cursor is flashing at the top left, which is where you start to create your program

Move the cursor, using the cursor buttons, across the hidden grid lines

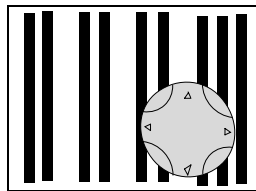

The first three double columns are contact fields and the right-hand triple column forms the coil field. Each line is a circuit connection. Pico adds the first contact automatically.

Now try to program the following Pico circuit diagram.

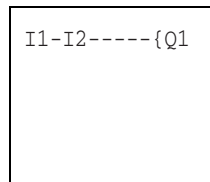

Switches S1 and S2 are wired to inputs I1 and I2. Relay K1 is represented by the relay coil {Q1. The symbol “{” identifies the coil's function, in this case a relay coil acting as a contactor. Q1 is one of up to six Pico output relays.

From the First Contact to the Output Coil

With Pico, you work from the input to the output.

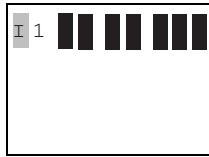

1. The first input contact is I1. Press Ok. Pico inserts the first contact I1 at the cursor position.

The 'I' flashes and can be changed, for example, to a 'P' for a button input using the up or down cursor buttons. However, nothing needs to be changed at this point.

2. Press Ok twice to move the cursor across the 1 to the next contact field.

You could also move the cursor to the next contact field using the right cursor button.

3. Press Ok.



Again, Pico creates a contact I1 at the cursor. Change the contact number to I2 since break contact (normally closed) S2 is connected to input terminal I2.

4. Press Ok. Then, press the up or down cursor button to change the number to 2. Press DEL to delete a contact at the cursor position.

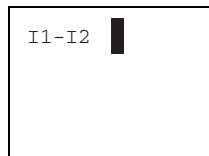

5. Press Ok to move the cursor to the third contact field. You do not need a third relay contact, so you can now wire the contacts directly to the coil field.

Wire Inside of Your Program

Pico displays a small arrow when creating a circuit connection.

Pressing Alt activates the arrow and the cursor buttons to move it. Alt also has two other functions:

- From the left contact field, press Alt to insert a new, empty circuit connection (rung).
- Press Alt to set the contact currently under the cursor to either a make or break contact.

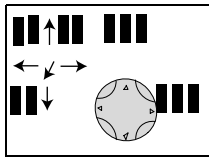

The wiring arrow works between contacts and relays. When you move the arrow onto a contact or relay coil, it changes back to the cursor and can be reactivated with Alt if required. Pico automatically wires adjacent contacts in a circuit connection up to the coil.

1. Press Alt to wire the cursor from I2 through to the coil field.

The cursor changes into a flashing wiring arrow and automatically jumps to the next possible wiring position.

2. Press the right cursor button.

Contact I2 is connected up to the coil field. Use the Del button to delete wiring at the cursor or arrow position. Where connections intersect, the vertical connections are deleted first, then, if you press Del again, the horizontal connections are deleted.

3. Press the right cursor button again.

The cursor will move to the coil field.

4. Press Ok.

Pico inserts relay coil Q1. The specified coil function 'I' and the output relay Q1 are correct and do not have to be changed.

Your first working Pico circuit diagram now looks like this:

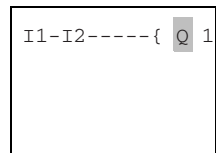

5. Press Ok. Then press Esc to leave the circuit diagram display. The diagram will be automatically saved.

Once you have connected buttons S1 and S2, you can test your circuit diagram.

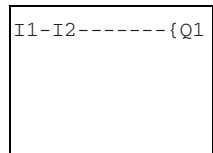

Test the Circuit Diagram

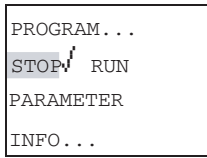

1. Switch to the main menu and select the RUN menu option (press Esc to go back to the Main Menu and use the arrow keys to highlight RUN).
2. Toggle between RUN and STOP to set the operating mode required (use the Ok button to toggle between RUN and STOP).

Pico is in Run mode if the STOP menu option is displayed. Menu options that toggle between two functions always show the next possible setting.

The status display shows the current mode and the switching states of the inputs and outputs.

3. Change to the Status display by pressing Esc and actuate push-button S1.

Pico 1760-L12xxx

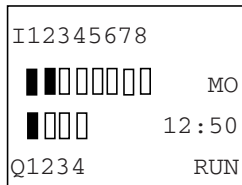

Pico 1760-L18xxx

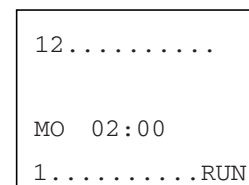

The boxes for inputs I1 and I2 are activated and relay Q1 is energized.

Power Flow Display

Pico allows you to check programs in Run mode. This means that you can check your circuit diagram via the built-in power flow display while it is being processed by Pico.

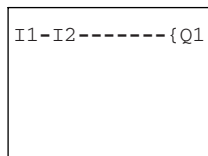

1. Press Ok twice to change to the Circuit diagram display and actuate push-button S1.

The relay energizes and Pico shows the flow of current.

2. Press push-button S2, that has been connected as a break contact.

The circuit connection is interrupted and relay Q1 drops out.

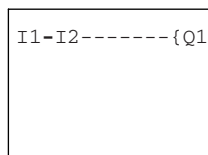

3. Press Esc to return to the Main Menu. A circuit diagram does not have to be completed before you can test parts of it with Pico.

Pico simply ignores any incomplete wiring that is not yet working and only uses the finished wiring.

Delete a Circuit Diagram

1. Switch Pico to Stop mode.

The RUN option is displayed. Pico must be in Stop mode in order to extend, delete or modify the program.

2. Select 'PROGRAM'. Press Ok to switch from the main menu to the next menu level.

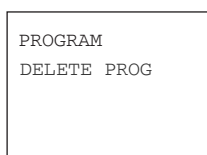

3. Select 'DELETE PROG'

Pico displays the prompt 'DELETE?'

4. Press Ok to delete the program or Esc to cancel.
5. Press Esc to return to the Main Menu.

Fast Circuit Diagram Entry

You can create a circuit diagram in several ways. The first option is to enter the elements in the circuit diagram and then wire all the elements together. The other option is to use the enhanced operator guidance and create the circuit diagram, from the first contact through to the last coil.

If you use the first option, you have to select some of the elements in order to create and connect your circuit diagram.



The second, faster option is what you learned in the example. In this case you create the entire circuit connection from left to right.



Draw a Circuit Diagram with Pico

By working through the example, Create a Circuit Diagram (Program) on page 3-4, you should have gained an initial impression on how to create a program in Pico. This chapter describes the full range of Pico functions and provides further examples of how to use Pico.

Pico Operation

Buttons for Drawing Circuit Diagrams

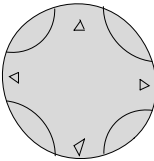
Press	To
	Delete branch, contact, relay, or empty rung in the circuit diagram.
	<ul style="list-style-type: none">• Toggle between break and make contact.• Connect contacts and relays.• Add circuit connections (rungs).

	<p>Up/Down Arrows</p> <ul style="list-style-type: none">• Change value.• Move cursor up and down. <p>Left/Right Arrows</p> <ul style="list-style-type: none">• Change between parameters.• Move cursor left and right. <p>Cursor Button Set to P-Button Function (if enabled)</p> <ul style="list-style-type: none">• Left Arrow = Input P1• Right Arrow = Input P3• Up Arrow = Input P2• Down Arrow = Input P4
	<ul style="list-style-type: none">• Undo settings from previous Ok• Exit current display
	<ul style="list-style-type: none">• Change or add a contact/relay.• Save the setting.

Button Operation

The cursor buttons in the Pico circuit diagram perform three functions. The current mode is indicated by the appearance of the flashing cursor:

- Move
- Enter
- Connect

 In Move mode, you can use the arrow keys to move the cursor around the circuit diagram in order to select a branch, contact or relay coil.

 Use Ok to switch to Enter mode so that you can enter or change a value at the current cursor position. If you press Esc in Enter mode, Pico will undo the most recent changes.

 Press Alt to switch to Connect mode for wiring contacts and relays. Press Alt again to return to Move.

Press Esc to leave the circuit diagram and parameter display. Pico performs many of these cursor movements automatically. For example, Pico switches the cursor to Move mode if no further entries or connections are possible at the selected cursor position.

Opening the Parameter Display

If you specify the contact of a relay type in Enter mode, Pico automatically switches from the contact number to the parameter display when you press Ok.

Press the right arrow to switch to the next contact or coil field without entering any parameters.





Contacts

Contacts are used to modify the flow of current in the circuit diagram. Contacts in the circuit diagram are either make or break contacts. Make contacts are open when off (de-energized) and closed when on. Break contacts are closed when off and open when on.

Usable Contacts

Contact	Pico Representation
Make contact; Open when off	I, Q, M, N, A, O, V, C, T, O, P, :, D, S, R, Z
Break contact; Closed when off	\bar{I} , \bar{Q} , \bar{M} , \bar{N} , \bar{A} , \bar{O} , \bar{V} , \bar{C} , \bar{T} , \bar{O} , \bar{P} , \bar{D} , \bar{S} , \bar{R} , \bar{Z}

Pico works with different contacts, which can be used in any order in the contact fields of the circuit diagram.

Contact Type	Make Contact	Break Contact	1760-L12xxx	1760-L18xxx 1760-L20xxx
Controller Inputs	I	\bar{I}	I1 to I8	I1 to I12
0 signal			I13	I13
Expansion Status			–	I14 ⁽³⁾
Short-circuit/overload			I16	I15 to I16
Soft Inputs - Keypad	P	\bar{P}	P1 to P4	P1 to P4
Controller Outputs	Q	\bar{Q}	Q1 to Q4	Q1 to Q8
Internal Marker Bits	M	\bar{M}	M1 to M16	M1 to M16
Internal Marker Bits	N	\bar{N}	N1 to N16	N1 to N16
Counters	C	\bar{C}	C1 to C16	C1 to C16
Timers	T	\bar{T}	T1 to T16	T1 to T16
Real Time Clock ⁽¹⁾		$\bar{\text{Clock}}$	 ₁ to  ₈	 ₁ to  ₈
Analog Setpoint Compare ⁽²⁾	A	\bar{A}	A1 to A16	A1 to A16
Text Display	D	\bar{D}	D1 to D16	D1 to D16
Expansion Outputs or Internal Marker Bits	S	\bar{S}	S1 to S8	S1 to S8
Jump to Label	:	–	:1 to :8	:1 to :8
Expansion Inputs	R	\bar{R}	–	R1 to R12
Expansion Overload Detection	R	\bar{R}	–	R15 and R16 ⁽³⁾

Contact Type	Make Contact	Break Contact	1760-L12xxx	1760-L18xxx 1760-L20xxx
Operating Hours Counter	O	\bar{O}	O1 to O4	O1 to O4
Year Time Switch	Y	\bar{Y}	Y1 to Y8	Y1 to Y8
Master Reset	Z	\bar{Z}	Z1 to Z3	Z1 to Z3

(1) Not available on “-NC” models.

(2) This applies only to the 1760-LxxBWB-xx and 1760-L12DWD.

(3) This applies only to 1760-L18xxx-EX models. R15 and R16 are used for expansion overload detection for the transistor expansion module, 1760-IB12XOB8, as described on page 9-4.

Relays

Pico has nine different types of relay for use in a circuit diagram.

Relay type	Pico Symbol	1760-L12xxx	1760-L18xxx 1760-L20xxx	Coil Function	Parameter
Controller Outputs	Q	Q1 to Q8	Q1 to Q8	X	–
Internal Marker Bits	M	M1 to M16	M1 to M16	X	–
Internal Marker Bits	N	N1 to N16	N1 to N16	X	–
Counters	C	C1 to C16	C1 to C16	X	X
Timers	T	T1 to T16	T1 to T16	X	X
Real Time Clock ⁽¹⁾				–	X
Operating Hours Counters	O	O1 to O4	O1 to O4	X	X
Analog Setpoint Compare ⁽²⁾	A	A1 to A16	A1 to A16	–	X
Text Display	D	D1 to D16	D1 to D16	X	X
Jump to Label	:	:1 to :8	:1 to :8	X	–
Expansion Outputs or Internal Marker Bits	S	S1 to S8 (as marker)	S1 to S8	X	–
Year Time Switch	Y	Y1 to Y8	Y1 to Y8	–	X
Master Reset	Z	Z1 to Z3	Z1 to Z3	X	–

(1) Not available on “-NC” models.

(2) This applies only to the 1760-LxxBWB-xx and 1760-L12DWD.

The switching behavior of these relays is set using coil functions and parameters. The coil functions and parameters are listed with the description of each function relay type.

The options for setting output and marker relays are listed with the description of each coil function.

Circuit Diagram Display

In the circuit diagram, contacts and coils are connected from left to right - from contact to coil. The circuit diagram is created on a hidden grid containing contact fields, coil fields and circuit connections. It is then wired with connections.

Insert relay contacts in the three contact fields. The first contact field is automatically connected to the voltage.

Insert the relay coil to be controlled together with its function and designation in the coil field.

Every line in the circuit diagram forms a circuit connection or ladder logic rung. Pico enables 128 circuit connections/rungs.

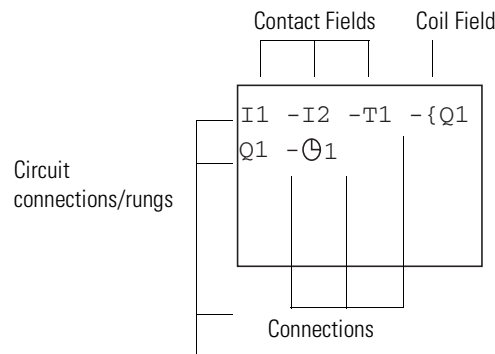

Connections are used to produce the electrical continuity between relay contacts and the coil. Connections can be created across several rungs. Each point of intersection is a connection. The circuit diagram display performs two functions:

- In Stop mode, it is used to edit the circuit diagram.
- In Run mode, it is used to check the circuit diagram using the Power flow display.

Save and Load Circuit Diagrams

There are two ways of saving circuit diagrams in Pico:

- Save to a memory module.
- Save to a PC running PicoSoft programming software.

Once they are saved, programs can be reloaded into Pico, edited, and run. All circuit diagram data is saved in Pico. In the event of a power failure, the data is retained until the next time it is overwritten or deleted.

Memory Module

Each memory module (1760-MM2B) can contain one circuit diagram, which is inserted into the Pico interface.

The 1760-MM1 and 1760-MM2 memory modules can be read on the Series B Pico controllers. The Series B Pico controllers can only write to the 1760-MM2B memory modules.

PicoSoft and PicoSoft Pro

PicoSoft are optional PC programs that allow you to create, store, test and manage Pico programs. Completed programs are transferred between your PC and Pico via the connecting cable. Once you have transferred a circuit diagram, you can monitor the program running in Pico directly from your PC.

Work with Contacts and Relays

In Pico circuit diagrams, the switches, buttons, and relays of conventional relay logic are connected using input contacts and relay coils.

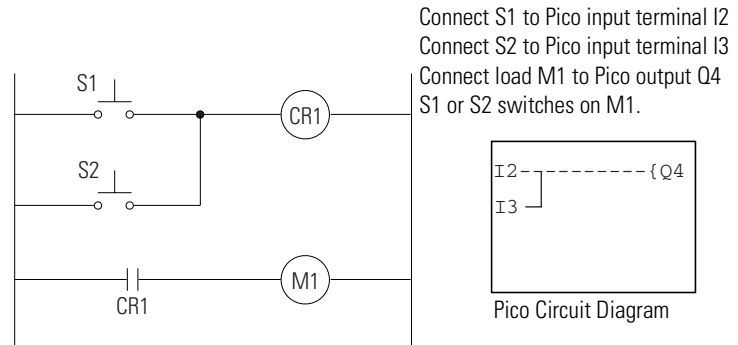

First, specify which input and output terminals you wish to use in your circuit.

Depending on the model, Pico controllers have 8, 12 or 24 input terminals and 4, 6, 8, 10 or 16 outputs. The signal states at the input terminals are recorded in the circuit diagram using input contacts I1 to I12. In the circuit diagram, the outputs are switched using output relays Q1 to Q6. The expansion modules can add another 12 inputs and 6 or 8 outputs. The signal states at the input terminals are recorded in the circuit diagram as R1 to R12. The outputs are switched using S1 to S8.

Enter or Modify the Contact or Relay

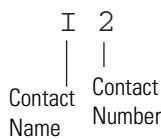

Define a contact in Pico via its name and number.

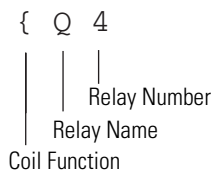

A relay is defined by its coil function, name and number.

A full list of all the contacts and relays is given on page 4-4. Enter mode is used to modify the value of contact fields and coil fields. The value to be modified will flash. If the field or section is empty, Pico will enter contact 'I1' or the coil '{Q1'.

- Move the cursor using the buttons to a contact or coil field.
- Press Ok to switch to Enter mode.
- Use the left and right arrow keys to select the position you wish to change, or press Ok to jump to the next position.
- Use the up and down arrow keys to modify the value of the position

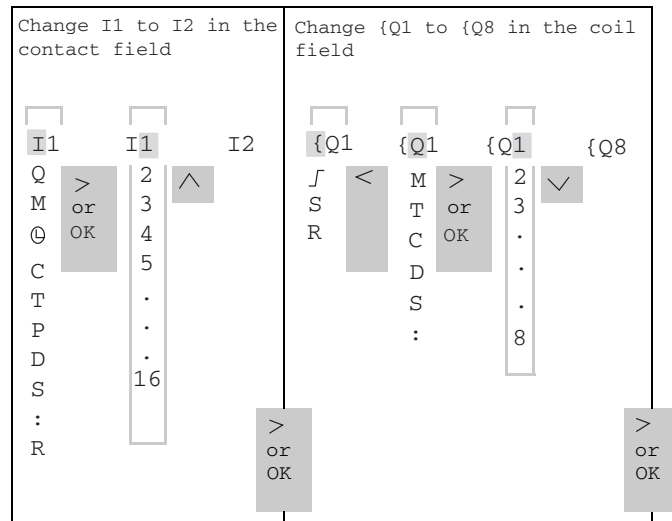

Pico leaves the Enter mode when you press the left or right arrow keys or Ok.

Deleting Contacts and Relay Coils

1. Move the cursor using the arrow buttons to a contact or coil field.
2. Press Del.

The contact or the relay coil is deleted, together with any connections.

Change Make Contacts into Break Contacts

Every relay contact in the circuit diagram can be defined as either a make or break contact.

1. Move the cursor over the contact and press Enter to change to the enter mode.
2. Press Alt. The make contact changes to a break contact.
3. Press Ok twice to confirm the change.

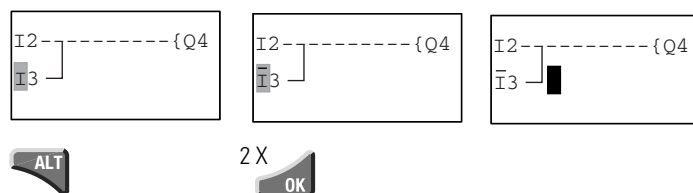

Create and Modify Connections

Relay contacts and relay coils are connected in Connect mode using the diagonal wiring arrow (available in this mode). Use the arrow buttons to move the cursor onto the contact field or coil field from which you wish to create a connection. Do not position the cursor on the first contact field. At this position, the Alt button has a different function (Insert circuit connection).

1. Press Alt to switch to Connect mode. 
2. Use the left and right arrows to move the diagonal arrow between the contact fields and coil fields and the up and down arrows to move between circuit connections.
3. Press Alt to leave Connect mode.

Pico leaves Connect mode automatically when you move the diagonal arrow onto a contact field or coil field which is already assigned. In a circuit connection, Pico automatically connects relay contacts and the terminal to the relay coil if there are no empty fields in-between.

IMPORTANT

Never work backward. Your circuit diagram may not perform as you expect it to.

When wiring more than three contacts in series, use one of 16 available marker relays 'M' or 'N'.

Do NOT do this:

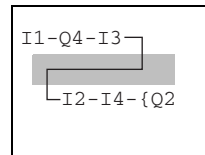

Do this instead:

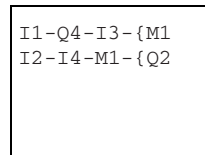

Delete Connections

1. Move the cursor onto the contact field or coil field to the right of the connection that you want to delete. Press Alt to switch to Connect mode.
2. Press Del.

Pico will delete a connection. Closed connections that are adjacent are retained.

If several circuit connections are connected to one another, Pico first deletes the vertical connection. If you press Del again, it deletes the horizontal connection as well. You cannot delete connections that Pico has created automatically.

3. Close the delete operation by pressing Alt or by moving the cursor to a contact or coil field.

Insert and Delete a Circuit Connection

The LCD display shows four of the 128 circuit connections in the display at the same time. Pico automatically scrolls the display up or down to show hidden circuit connections—even empty ones—if you move the cursor past the top or bottom of the display.

A new circuit connection is added below the last connection or inserted above the cursor position:

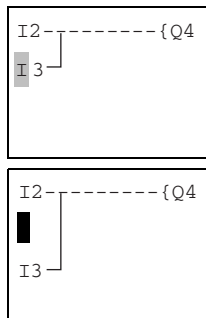

1. Position the cursor on the first contact field of a circuit connection.
2. Press Alt.

The existing circuit connection, with all its additional connections, is shifted down. The cursor is then positioned directly in the new circuit connection.

Delete a Circuit Connection

Pico only removes empty circuit connections, i.e. those without contacts or coils.

1. Delete all the contacts and relay coils from the circuit connection.
2. Position the cursor on the first contact field of the empty circuit connection.
3. Press Del.

The subsequent circuit connection(s) is 'pulled up' and any existing links between circuit connections are retained.

Use the Cursor Buttons as Inputs

With Pico, you can also use the four cursor buttons as soft inputs in the circuit diagram.

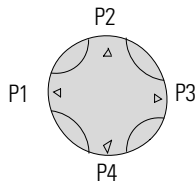

The buttons are contacts P1 to P4 in the circuit diagram. The P-Buttons can be activated and deactivated in the System menu.

The P-Buttons can also be used for testing circuits or manual operation. These button functions are also useful for servicing and commissioning purposes.

Example 1

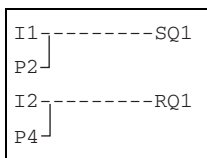

A lamp at output relay Q1 is turned on and off via inputs I1 and I2 or using cursor buttons up and down.

Example 2

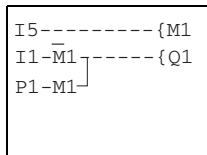

Input 'I1' is used to control output 'Q1'. Input I5 switches to Cursor button mode and deactivates circuit connection I1 via $\bar{M}1$.

IMPORTANT

The P-Buttons are only recognized as switch contacts in the Status menu display, and not in the circuit diagram display.

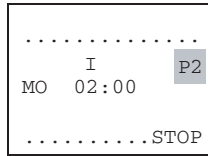

The Status menu display shows whether the P-Buttons are used in the circuit diagram.

Display	Function
P	Button function active
P2	Button function active and P2 button pressed
P-	Button function not active
	Empty box: P buttons not used.

Check the Circuit Diagram

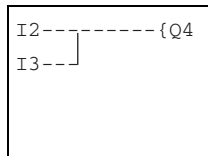

Pico allows you to monitor the switching states of contacts and relay coils during operation.

1. Complete the small parallel connection and switch Pico to Run mode via the main menu.
2. Return to the circuit diagram display.

You are now unable to edit the circuit diagram.

IMPORTANT

If you switch to the circuit diagram display and are unable to modify a circuit diagram, first check whether the unit is in Stop mode.

The circuit diagram display performs two functions depending on the mode:

- STOP: Create circuit diagrams
- RUN: Show power flow display

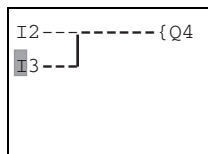







Switch on I3.

In the power flow display, current-carrying connections are thicker than those that are not powered.

You can follow a current-carrying connection across all circuit connections by scrolling the display up and down. The power flow display will not show signal fluctuations in the millisecond range. This is due to the inherent delay factor of LCD displays.

Coil Functions

You can set the coil function to determine the switching behavior of relay coils. The following coil functions are available for relays Q, M, S, D and '':.

Circuit Diagram Symbol	Pico Symbol	Coil Function	Example
	{	Output Energize Function	{Q1, {D2, {S4, { :1, {M5
	}	Output Negated Function	}Q1, }D2, }S4
	┘	Cycle pulse falling edge	┘Q3, ┘M4, ┘D8, ┘S7
	┙	Cycle pulse raising edge	┙Q3, ┙M4, ┙D8, ┙S7
	┘┙	Maintained/Flip-Flop Function	┘Q3, ┘M4, ┘D8, ┘S7
	S	Set (latching)	SQ6, SM2, SD3, SS4
	R	Reset (unlatching)	RQ4, RM5, RD7, RS3

The marker relays M and N are used as a flag. The S relay can be used as the output of an expansion module or, as a marker if no expansion module is connected. When used as markers, the only difference between them and the output relay Q is that they have no output terminals. The functions of timer and counter relays are explained in the relevant relay description. The coil function { (output energize) should only be used once on each coil. Otherwise, the last coil in the circuit diagram determines the status of the relay.

To ensure proper operation of all relay states, only assign the same coil function once to a relay (S, R).

Exception: The coil function can be used properly several times when using jumps to structure the circuit diagram.

Rules for Wiring Relay Coils

Use the output energize or 'flip-flop' function once only for each relay coil.

Use the 'latch' and 'unlatch' functions to control each relay coil - the first to set it (S) and the second to reset it (R).

Relays with Output Energize Function



The output signal follows immediately after the input signal, and the relay acts as a contactor.

Signal Diagram:

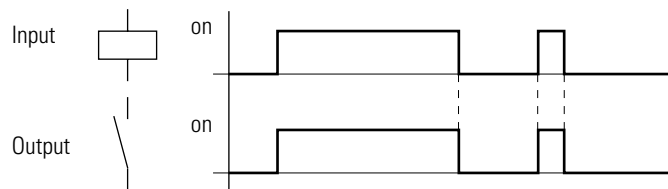

Instruction Type	Representation in Pico
Output Relay Q	{Q1...{Q6 (depending on type)
Marker Relay M	{M1...{M16, {N1...{N16
Text Display Relay D	{D1...{D16
Expansion or Marker Relay	{S1...{S8 (1760-L18xxx)
Jumps	{:1...{:8 (1760-L18xxx)

Relays with Output Energize Negate Function

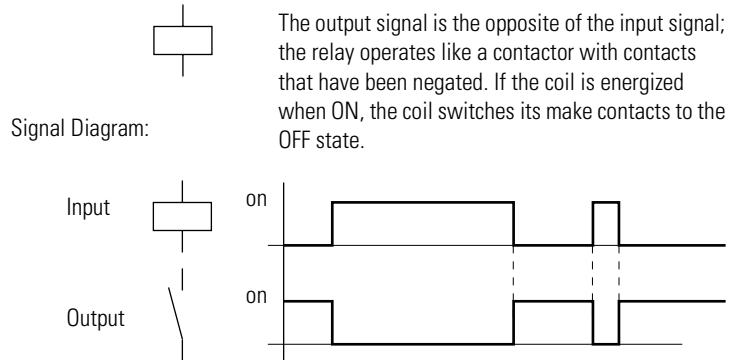

Instruction Type	Representation in Pico
Output Relay Q	}Q1...}Q6 (depending on type)
Marker Relay M	}M1...}M16, }N1...}N16
Text Display Relay D	}D1...}D16 (1760-L18xxx)
Expansion or Marker Relay	}S1...}S8 (1760-L18xxx)
Jumps	}:1...}:8 (1760-L18xxx)

Relays with Falling Edge Function

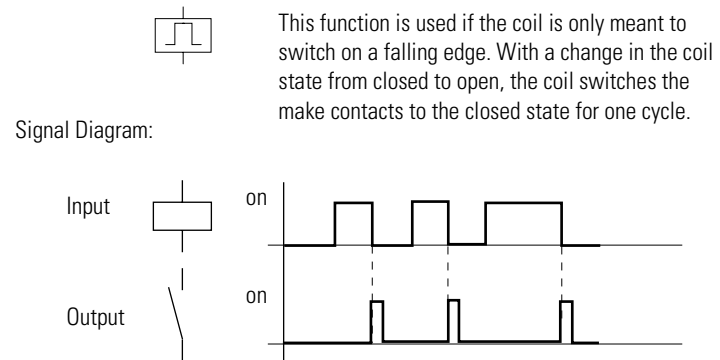

Instruction Type	Representation in Pico
Marker Relay M, N	!rM1...!rM16, !rN1...!rN16
Jumps	!r:1...!r:8 (1760-L18xxx)

Physical outputs should not be used when a cycle pulse is generated.

Relays with Raising Edge Function



This function is used if the coil is only meant to switch on a rising edge. With a change in the coil state from open to closed, the coil switches its make contacts to the closed state for one cycle.

Signal Diagram:

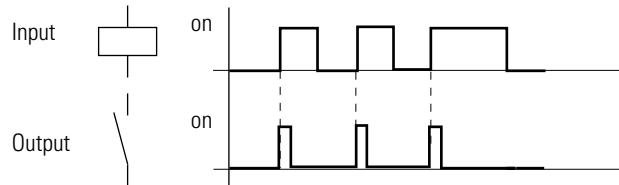

Instruction Type	Representation in Pico
Marker Relay M, N	\uparrow M1... \uparrow M16, \uparrow N1... \uparrow N16
Jumps	\uparrow :1... \uparrow :8 (1760-L18xxx)

Physical outputs should not be used when a cycle pulse is generated.

Maintained/Flip-Flop Relay



The relay coil switches state whenever the input signal changes from 0 to 1. The relay behaves like a flip-flop.

Signal Diagram:

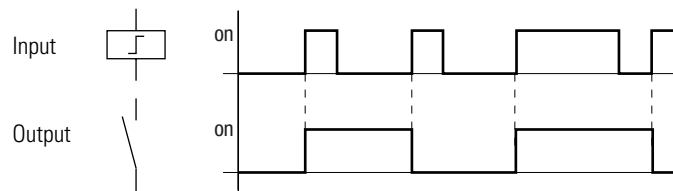

Instruction Type	Representation in Pico
Output Relay Q	\lrcorner Q1... \lrcorner Q8 (depending on type)
Marker Relay M	\lrcorner M1... \lrcorner M16
Text Display Relay D	\lrcorner D1... \lrcorner D8 (1760-L18xxx)
Expansion or Marker Relay	\lrcorner S1... \lrcorner S8 (1760-L18xxx)

A coil automatically turns off if the power fails or if Pico is in Stop mode.

Exception: Retentive coils retain signal 1 (see Chapter 7).

Latching Relay

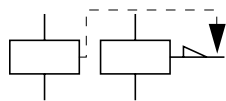

The 'latch' and 'unlatch' relay functions are used in pairs. The relay picks up when latched and remains in this state until it is reset by the 'unlatch' function.

Signal Diagram:

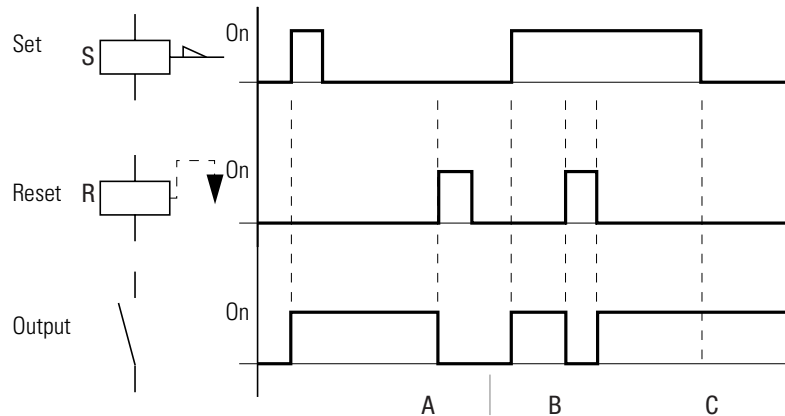

- A - The Set coil and the Reset coil are triggered at different times.
- B - Reset coil is triggered at the same time as the Set coil.
- C - Power supply switched off.

Instruction Type	Representation in Pico
Output Relay Q	SQ1...SQ8, RQ1...RQ8 (depending on type)
Marker Relay M	SM1...SM16, RM1...RM16
Text Display Relays D	SD1...SD8, RD1...RD8 (1760-L18xxx)
Expansion or Marker Relay	SS1...SS8, RS1...RS8 (1760-L18xxx)

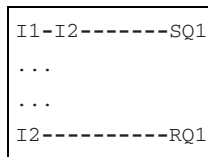







Use relay functions 'S' and 'R' only once per relay. If both coils are triggered at the same time, priority is given to the coil further down in the circuit diagram. This is shown in the preceding signal diagram in section 'B'.

IMPORTANT

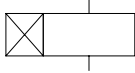
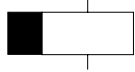
A latched relay is automatically switched off if the power fails or if the device is in Stop mode.
Exception: Retentive coils retain signal 1 (see What is Retention? on page 7-1).

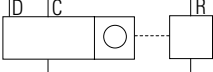
Function Relay Types

The function relays are used to simulate some of the devices used in conventional relay control systems. Pico provides the following function relay types:

Circuit Diagram Symbol	Function Relay Type
	Timing relay, on-delayed Timing relay, on-delayed with random switching
	Timing relay, off-delayed Timing relay, off-delayed with random switching
	Timing relay, single pulse Timing relay, flashing
	Counter relay, up/down counter
	Time switch, weekday/time (only in Pico models with real time clock)
	Analog comparator relay (only in Pico 24V dc models)
	Text display

A function relay is started via its relay coil or by evaluating a parameter. It switches the contact of the function relay according to its function and the set parameters. Current actual values are erased if the power is turned off or if the unit is switched to Stop mode.

Exception: Retentive coils retain their signal (see Chapter 7).

In timing and counter relays, it is also possible to change the switching behavior via the coil function.

ATTENTION



In Run mode, Pico processes the function relays after a pass through the circuit diagram. The last state of the coils is used for this.

Only use the coil of a function relay once.

Exception: The same coil can be used several times when working with jumps.

Example with Timing and Counter Relays

A warning light flashes when the counter reaches 10.

Hard-Wire with Relays

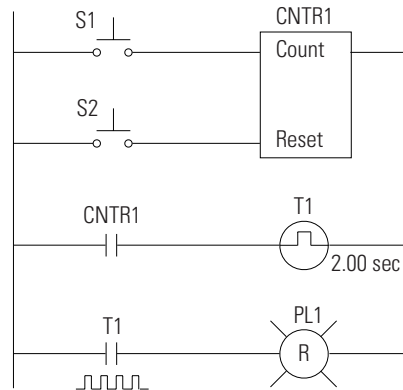

I5	-----	CC1
I6	-----	RC1
C1	-----	TT1
T1	-----	{Q1

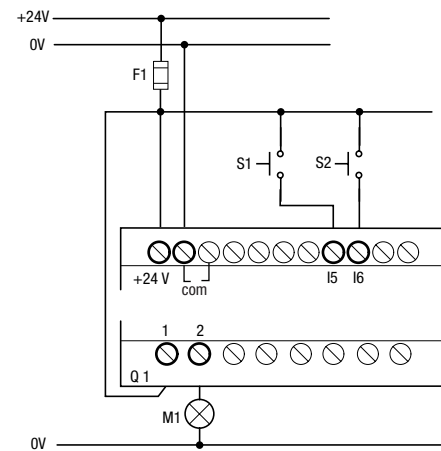

Use Circuit Diagram Forms

You can use the circuit diagram form on page B-1 of this manual for planning and preparing your Pico circuit diagrams. An example form is shown below and on the next page.

Customer: J. Smith Ltd. Program: Warning Light
 Date: 5-1-00 Page: 1

Comment:

<table border="0" style="width: 100%; border-collapse: collapse;"> <tr> <td style="border: 1px solid black; padding: 2px;">I</td> <td style="border: 1px solid black; padding: 2px;">5</td> <td style="border: 1px solid black; width: 20px; height: 15px;"></td> <td style="border: 1px solid black; width: 20px; height: 15px;"></td> <td style="border: 1px solid black; width: 20px; height: 15px;"></td> <td style="border: 1px solid black; width: 20px; height: 15px;"></td> <td style="border: 1px solid black; padding: 2px;">C</td> <td style="border: 1px solid black; padding: 2px;">C</td> <td style="border: 1px solid black; padding: 2px;">1</td> </tr> <tr> <td style="border: 1px solid black; padding: 2px;">I</td> <td style="border: 1px solid black; padding: 2px;">6</td> <td style="border: 1px solid black; width: 20px; height: 15px;"></td> <td style="border: 1px solid black; width: 20px; height: 15px;"></td> <td style="border: 1px solid black; width: 20px; height: 15px;"></td> <td style="border: 1px solid black; width: 20px; height: 15px;"></td> <td style="border: 1px solid black; padding: 2px;">R</td> <td style="border: 1px solid black; padding: 2px;">C</td> <td style="border: 1px solid black; padding: 2px;">1</td> </tr> <tr> <td style="border: 1px solid black; padding: 2px;">C</td> <td style="border: 1px solid black; padding: 2px;">1</td> <td style="border: 1px solid black; width: 20px; height: 15px;"></td> <td style="border: 1px solid black; width: 20px; height: 15px;"></td> <td style="border: 1px solid black; width: 20px; height: 15px;"></td> <td style="border: 1px solid black; width: 20px; height: 15px;"></td> <td style="border: 1px solid black; padding: 2px;">T</td> <td style="border: 1px solid black; padding: 2px;">T</td> <td style="border: 1px solid black; padding: 2px;">1</td> </tr> <tr> <td style="border: 1px solid black; padding: 2px;">T</td> <td style="border: 1px solid black; padding: 2px;">1</td> <td style="border: 1px solid black; width: 20px; height: 15px;"></td> <td style="border: 1px solid black; width: 20px; height: 15px;"></td> <td style="border: 1px solid black; width: 20px; height: 15px;"></td> <td style="border: 1px solid black; width: 20px; height: 15px;"></td> <td style="border: 1px solid black; padding: 2px;">[</td> <td style="border: 1px solid black; padding: 2px;">Q</td> <td style="border: 1px solid black; padding: 2px;">1</td> </tr> </table>	I	5					C	C	1	I	6					R	C	1	C	1					T	T	1	T	1					[Q	1	<p>Counter (Value 10)</p> <hr/> <p>Reset Counter</p> <hr/> <p>Trigger flash/blink relay</p> <hr/> <p>Warning light, flash 2s</p> <hr/> <hr/> <hr/> <hr/> <hr/> <hr/> <hr/> <hr/> <hr/> <hr/> <hr/> <hr/> <hr/> <hr/> <hr/> <hr/>
I	5					C	C	1																													
I	6					R	C	1																													
C	1					T	T	1																													
T	1					[Q	1																													

Customer: J. Smith Ltd. Program: Warning Light

Date: 5-1-00 Page: 2

Timing relays

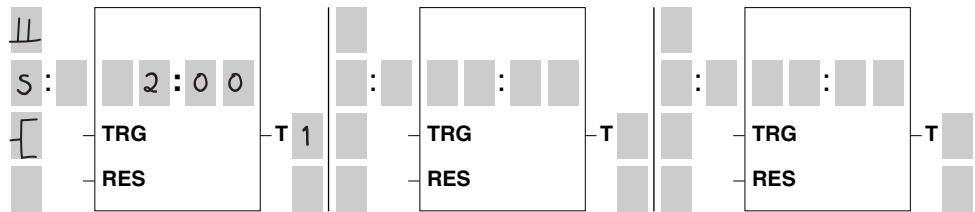

Analog comparators

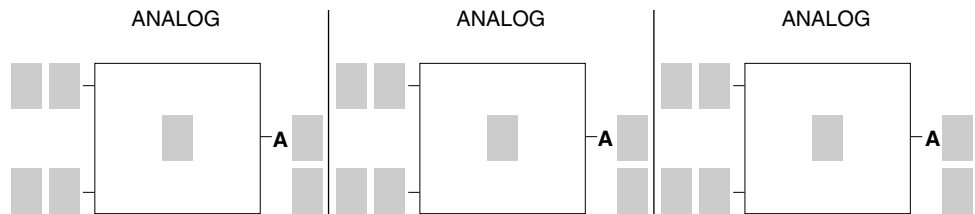

Timing switches

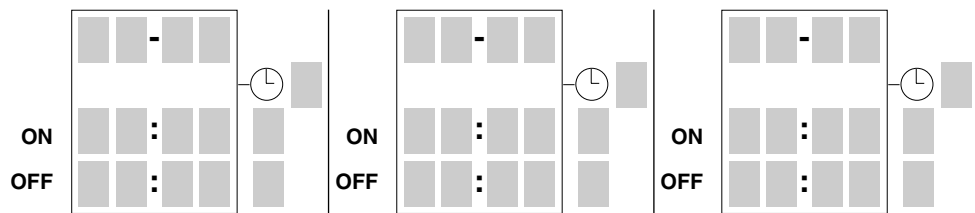

Up/down counters

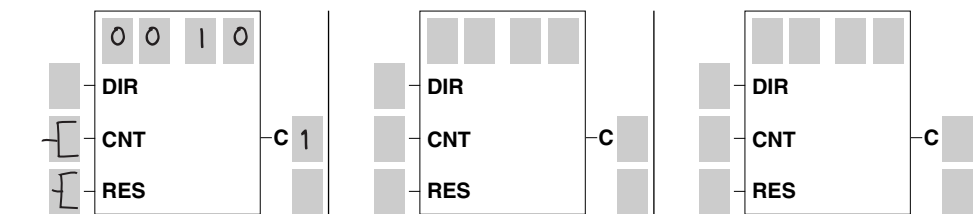

```
I5-----CC1
```

1. Enter the circuit diagram up to CC1.

CC1 is the contact of counter relay 1. If the cursor is on the contact number, Pico will call up the parameter display when you press Ok.

2. Move the cursor onto the 1 in CC1 and press Ok.

```
C1 N      +
S      +0
```

The parameter set for the counter is displayed.

3. Move the cursor onto the plus sign to the right of the S (setpoint) and press Ok.

```
C1 N      +
S      00000
```

4. Change the counter setpoint to 10:

Use the left and right buttons to move the cursor onto the tens digit.

```
C1 N      +
S      00010
```

Use the up and down buttons to modify the value of the digit.

5. Press Ok to save the value and Esc to return to the circuit diagram. Pico has specific parameter displays for function relays. The meaning of these parameters is explained under each relay type.

```
I5-----CC1
I6-----RC1
C1-----TT1
```

6. Enter the circuit diagram up to contact 'TT1' of the timing relay. Set the parameters for T1.

The timing relay works like a flasher/blink relay. The Pico symbol for the flasher/blink relay is shown in the screen to the left. It is set at the top left of the parameter display.

7. Press the down arrow and select the flasher/blink relay symbol.

```
T1  S +
I1      +0
I2      +0
T:
```

8. Use the right arrow to move to the first time setpoint I1.

9. Press Ok, then press the right arrow.

10. Use the arrows to enter the value 01.000 and press Ok.

The time setpoint I1 for the pause time is 1 second.

```
T1  S +
I1      01.000
I2      00.500
T:
```

11. Use the down arrow to enter the value of the second setpoint I2.

Set this value to 0.5 seconds. This is the time value for the pulse time.

12. Press Esc to leave the parameter entry.

The values are now stored.

```
I5-----CC1
I6-----RC1
C1-----TT1
T1-----{Q1
```

13. Complete the circuit diagram.

14. Press Ok to store the circuit diagram.

Test Circuit Using Power Flow Display

1. Switch Pico to Run mode and return to the circuit diagram.

Each parameter set can be displayed using the power flow display for the circuit diagram.

```
C1 N      +
S      0010
[ ] C: 0000
```

2. Move the cursor onto C1 and press Ok.

The parameter set for the counter is displayed with actual and setpoint values.

```
C1 N      +
S      0010
[ ] C: 0007
```

3. Switch I5. The actual value changes.

This is represented in the Pico parameter display. In the last line C: 0007 the counter actual value is equal to seven.

```
C1 N      +
S      0010
■ C: 0010
```

If the actual value is greater than or equal to the setpoint (10), the left character on the bottom row changes to a black box. The contact of counter C1 switches.

The counter contact triggers the timing relay. This causes the warning light to flash at output Q1.

Double the flashing frequency:

```
T1 ||      S +
S1  00.500
S2  00.250
■ T: 00.200
```

1. Select T1 in the power flow display and press Ok.

2. Change the set time I1 to 00.500 and I2 to 00.250 (0.5 and 0.25 s).

3. Press Ok to save the set time.

The character on the left of the bottom row indicates whether the contact has switched or not.

Protect Timer and Counter Settings

You can also modify parameter settings via the PARAMETER menu option. If you want to prevent other people from modifying the parameters, change the access enable symbol from '+' to '-' when creating the circuit diagram and protect the circuit diagram with a password.

Timing Relays

Pico provides sixteen different timing relays, T1 to T16.

A timing relay is used to change the switching duration and the make and break times of a relay contact. The possible delay times range between 2 ms and 100 hours. You can use positive values, values of analog inputs, and actual values of counter relays and timing relays.

IMPORTANT

The timing relays of Pico Series B controllers function in the same way as the timing relays of Pico Series A controllers.

The one exception is the 'flash' function. Pico Series B starts with the pulse. In Series A controllers the 'flash' function starts with the pause. If required, the same timing relays can also be used for retentive data.

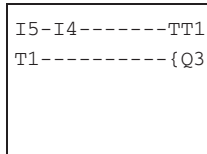

You integrate a timing relay into your circuit in the form of a contact and coil.

Contact	Coil
T1 to T16	Contact of a timing relay
TT1 to TT16	Enable, timing relay trigger
RT1 to RT16	Reset coil of the timing relay
HT1 to HT16	Stop coil of the timing relay (H=Stop, S means the Set coil function)

IMPORTANT

To prevent unpredictable switching states, use each coil of a relay only once in the circuit diagram.

Parameter Display and Parameter Set for a Timing Relay

T1	X	S	+
I1		00.000	
I2		00.000	
T:			

T1	Timing relay number 1
X	On-delayed mode
S	Time range in seconds
+	<ul style="list-style-type: none"> • + appears in the Parameter menu • - does not appear in the Parameter menu
I1	Time setpoint 1: <ul style="list-style-type: none"> • Positive value, I7, I8, I11, I12 • Actual value T1 to T16, C1 to C16
I2	Time setpoint 2: <ul style="list-style-type: none"> • Positive value, I7, I8, I11, I12 • Actual value T1 to T16, C1 to C16
T:	Display of actual value in Run mode

In the parameter display of a timing relay you can change the mode, the time base, the time setpoint 1, time setpoint 2 (if necessary) and the enable of the parameter display.

Compatibility Between Pico Series A and Pico Series B Controllers

New functions have been added to the parameter display of the Pico Series B Controllers. The Series A parameters can be found at the following points:

Pico Series A

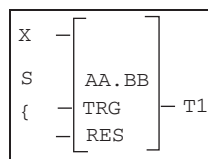

T1 = T1
 X = X
 S = S
 AA.BB = AA.BB
 + = +

Pico Series B

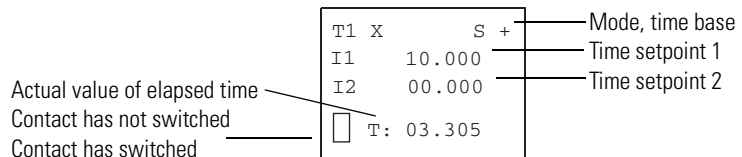
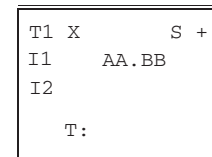

Programming a Timing Relay

Task:
 Turn on output Q1 1.5 min.
 after actuation via I1.
 Disable T2 via I2.

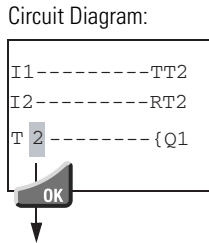

Parameter Display:

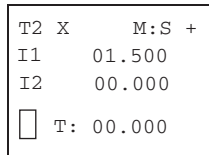

A timing relay is integrated into your circuit in the form of a contact. The function of the relay is defined via the parameter display. The relay is started via the trigger input TRG and can be reset via the reset input RES. A timer also resets when it is turned off. To prevent unpredictable switching states, use each coil of a relay only once in the circuit diagram.

At least two elements are needed in the circuit diagram for a timing relay:

- A relay contact in the contact field, in this case T2.
- A trigger coil in the coil field, in this case TT2.

You can also wire up the reset coil RT2 if you wish to use an external reset signal. Enter the number of the relay contact T2 and press Ok.

The parameter set for timing relay T2 is displayed. Specify the function of the relay.

Parameters for Timers

The parameter display for a timing relay is used to modify the switching function, setpoint time and timebase units and to enable or disable parameter access.

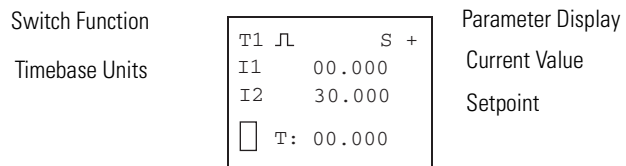

The coil terminals are not shown if you access the parameters via the PARAMETER menu option. The actual time is only displayed in Run mode. To view the actual time, call up the parameter display via the power flow display or using the PARAMETER option.

Switch Function Parameters	Description
X	Switch with on-delay
?X	Switch with on-delay and random time range
■	Switch with off-delay
X■	Switch with off-delay and random time range
⌈⌋	Switch with single-pulse
⌈⌋	Switch with flashing

Typically, delay times are >40 ms for the 1760-L12xxx and >80 ms for the 1760-L18xxx. This is because a time value less than the maximum scan time of the Pico controllers may cause uncontrolled switching states.

Time Units and Setpoint Time Parameters		Resolution
S 00.00	Seconds 10 x milliseconds, 00.00 to 99.99	10 ms
M:S 00:00	Minutes: seconds, 00:00 to 99:59	1 s
H:M 00:00	Hours: minutes, 00:00 to 99:59	1 min.

Parameter Set Displayed via the PARAMETER Menu Option	
+ Access enabled	- Access disabled

Timing Relays, On-Delay, Without and With Random Switching

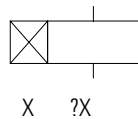

The relay switches a contact after the setpoint delay has elapsed. With random switching, the relay contact switches randomly at any time up to the specified time value (shown shaded in figure).

Timing Diagram

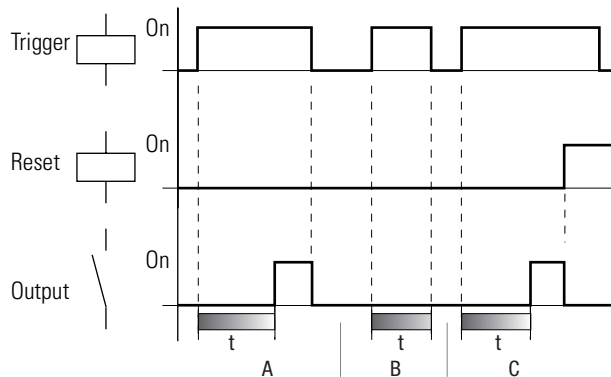

The trigger input starts the time (t). If the trigger input is disabled after the time has elapsed, timer is reset and the output is turned off (A). If the trigger coil drops out before the time has elapsed, the contact is not turned on (B). The reset coil has priority over the trigger coil and always resets the timer and turns the output off (C). If the preset is set to zero, the output follows immediately after the trigger signal.

Typical applications include:

- Switching conveyor belts on or off after a delay
- Detecting gaps in the switching of sensors in the event of a fault
- Automatic window shutter control with random switching times

Timing Relays, Off-Delayed With and Without Random Switching

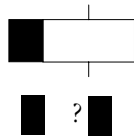

The relay switches a contact immediately and then resets it after the setpoint delay has elapsed. With random switching, the relay contact switches randomly at any time up to the specified time value (shown shaded in figure).

Timing Diagram

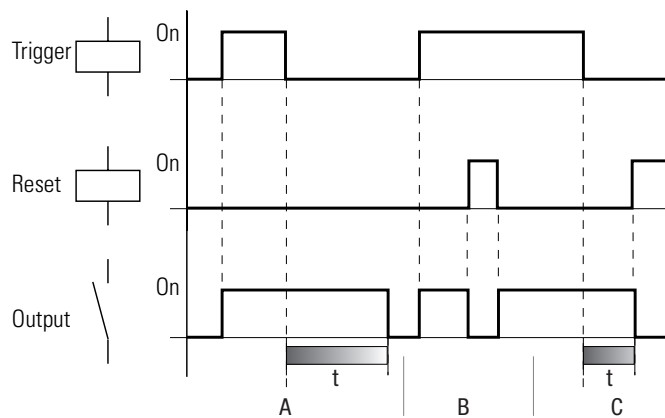

The trigger coil switches the contact. If the trigger coil (A) drops out, the setpoint time starts and resets the contact after the time has elapsed. The reset coil has priority over the trigger coil and always resets the relay contact (B, C). If the time is set to zero, the contact follows immediately after the trigger signal.

Typical applications include:

- Activating the deceleration of motors or fans
- Automatic lighting control for vacant buildings with random switching times

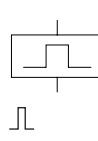
 *Timing Relays, Single Pulse*
 The relay switches a contact for a time equal to the delay time set, regardless of the length of the trigger signal.

Signal Diagram:

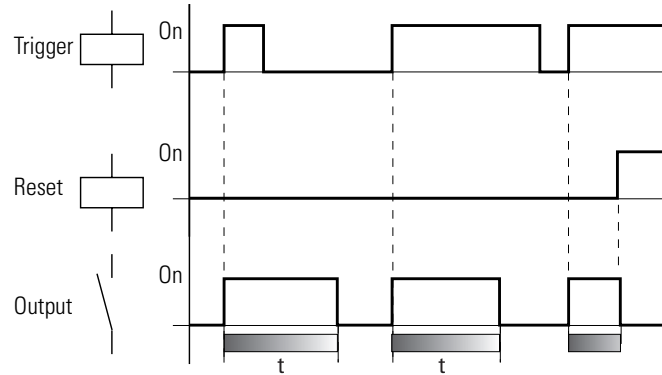

The reset coil has priority over the trigger coil and resets the relay contact before the time has elapsed. If the time is set to zero, the contact is set for the duration of one program scan.

The cycle time varies according to the length of the circuit diagram.

Typical applications include:

- Adjusting switching signals to a defined pulse length
- Shortening pulses to the duration of a cycle (one-shot)

Timing Relays, Flashing

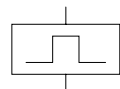
 ≡ = flash

The relay closes and opens the relay contact alternately with the flashing frequency.

$$\text{Flash Frequency} = \frac{1}{2 \times \text{Set Time}}$$

EXAMPLE

Set Time: 0.2s, Flash Frequency = $\frac{1}{0.4s} = 2.5 \text{ Hz}$

Signal Diagram:

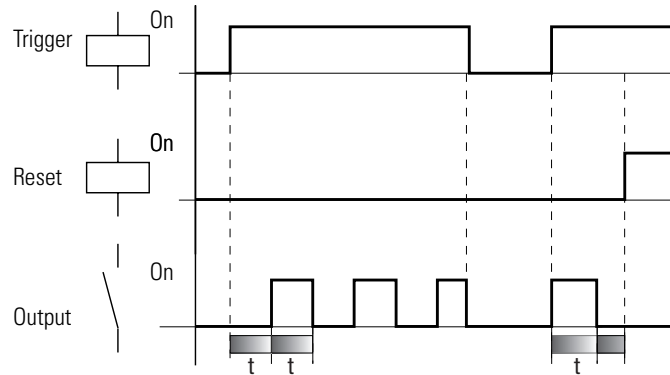

The trigger coil enables the flashing on and off. The flashing period starts with switch position 'off'. The reset coil has priority over the trigger coil and always resets the relay contact.

If the time is set to zero, the flash frequency changes with the cycle time. The cycle time varies according to the length of the circuit diagram.

A typical application is activating warning lamps.

Counter Relays

Pico works with counter relays C1 to C16.

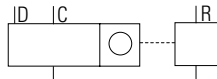

The counter relay adds or subtracts pulses and switches if the actual value is greater than or equal to the setpoint value. Values between 0000 and 9999 are possible.

A counter relay can be controlled via the counting pulse CCx, counting direction DCx and reset RCx relay functions.

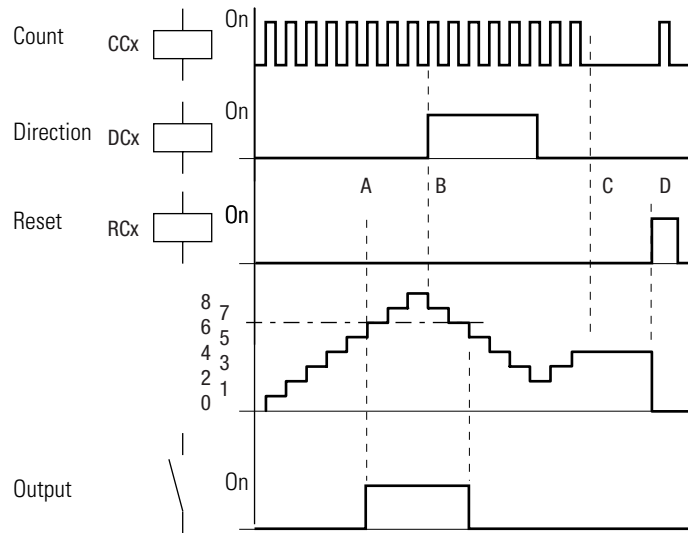
Signal Diagram:

The relay contact of a counter with setpoint value 6 switches when the actual value is 6 (A). If the counting direction is reversed (B), the contact switches off when the actual value is 5. Without a counting pulse, the actual value is retained (C). The reset coil resets the counter to 0 (D).

Possible applications include the counting of components, lengths or event frequency.

Program a Counter Relay

You can integrate a counter relay into your program in the form of a contact and coil. Counter relay C1 receives counting pulses via the count coil CC1. The counting direction can be changed via the direction coil DC1:

- If DC1 = 0, relay C1 counts up.
- If DC1 = 1, relay C1 counts down.

The Reset coil RC1 is used to reset the counter to 0.

Contact C1 is used to process the result of the counter in the circuit diagram. To prevent unpredictable operation, use each coil of a relay only once in the circuit diagram.

Enter at least one contact and a coil in your circuit diagram:

- A relay contact in the contact field, in this case C1
- A count coil in the coil field, in this case CC1

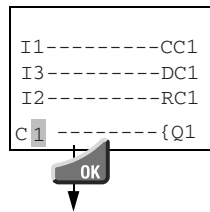

You can wire up coils RC1 and DC1 as required. Select relay contact C1, move the cursor to 1 and press Ok.

The parameter set for counter relay C1 is displayed.

Determine Counter Frequency

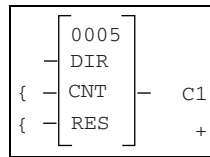

The maximum counter frequency depends on the length of the circuit diagram in Pico. The number of contacts, coils and circuit connections used determines the scan time (cycle time) required to process the Pico circuit diagram.

EXAMPLE

When using a Pico with only three circuit connections for counting, resetting and outputting the result via the output, the counter frequency may be 100 Hz.

To determine the scan time refer to Determine Cycle Time of Circuit Diagrams on page 8-3.

The maximum counter frequency depends on the maximum scan time.

Use the following formula to determine the maximum counter frequency:

$$f_c = \frac{1}{2 \times t_c} \times 0.8$$

f_c = maximum counter frequency

t_c = maximum scan time

0.8 = correction factor

EXAMPLE

The maximum scan time is $t_c = 4000 \mu\text{s}$ (4 ms).

$$f_c = \frac{1}{2 \times 4 \text{ ms}} \times 0.8 = 100 \text{ Hz}$$

Parameters for Counters

The parameter display for counters is used to change the counter setpoint value and to enable or disable parameter access.

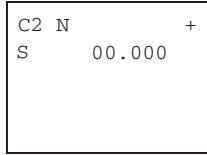

C2	Counter function relay number 2
N	<ul style="list-style-type: none"> • Mode N: up/down counter • Mode H: high-speed up/down counter • Mode F: frequency counter
+	<ul style="list-style-type: none"> • + appears in the Parameter menu • - does not appear in the Parameter menu.
S	Setpoint, constant from 00000 to 32000

Parameter	Coil Function	Meaning
DIR	DC1 to DC16	Counting direction Coil not triggered: count up Coil triggered: count down
CNT	CC1 to CC16	Counting pulse
RES	RC1 to RC16	Reset, coil triggered: actual value reset to 00000

The symbol ‘†’ before DIR, CNT and RES indicates whether the coil function is programmed in the circuit diagram.

Parameters Displayed via the PARAMETER Menu Option	
+ Access enabled	- Access disabled

The actual value is only displayed in Run mode. The parameter display can then be called via the power flow display or via the PARAMETER option from the main menu.

The coil symbol is not displayed if you select the parameter display via the PARAMETER menu option.

The counter relay counts between 0 and 32000.

When the Pico is in Run mode and the value of 32000 is reached, this value is retained until the count direction is changed. If the value of

00000 is reached, this value is retained until the count direction is changed.

Compatibility between Pico Series A Controllers and Pico Series B Controllers

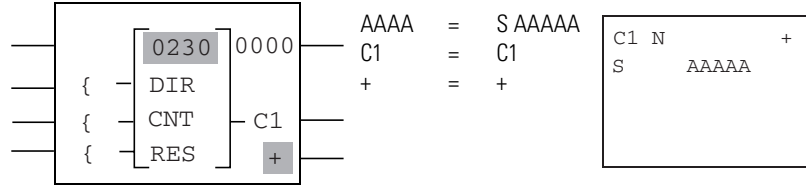

High Speed Counters

Pico provides various high-speed counter functions. These counter function blocks are coupled directly to digital inputs. The following functions are possible:

- Frequency counters: C15 and C16
- High-speed counters: C13 and C14

Frequency Counters

Pico provides two frequency counters, C15 and C16, for use as required. The frequency counters can be used for measuring frequencies. The high-speed frequency counters are permanently connected to the digital inputs I3 and I4.

Frequency counters C15 and C16 can be used for determining motor speeds, volume measurement using volume meters or the running of a motor.

The frequency counter allows you to enter an upper threshold value as a comparison value. The C15 and C16 frequency counters are not dependent on the cycle time.

Counter Frequency and Pulse Shape

The maximum counter frequency is 1 kHz and the minimum counter frequency is 4 Hz. The signals must be square waves with a mark-to-space ratio of 1:1. If this is not the case, then the minimum mark-to-space ratio is 0.5 ms.

$$t_{min} = 0.5 \times \frac{1}{f_{max}}$$

t_{min} = minimum time of the pulse or pause duration
 f_{max} = maximum count frequency (1 kHz)

IMPORTANT Frequency counters operate independently of the program cycle time. The result of the actual value setpoint comparison is only transferred once every program cycle for processing in the circuit diagram.

The reaction time in relation to the setpoint/actual value comparison can therefore be up to one cycle.

Measurement Method

The pulses on the input are counted for one second regardless of the cycle time, and the frequency is determined. The measurement result is provided as an actual value.

Wire a Frequency Counter

The following assignment of the digital inputs apply.

- I3 counter input for frequency counter C15.
- I4 counter input for frequency counter C16.

IMPORTANT If you use C15 or C16 as frequency counters, coils DC15 or DC16 will have no function. The counter signals are transferred directly from the digital inputs I3 and I4 to the counters. A frequency counter measures the actual value and does not measure a direction.

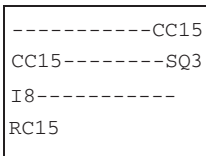

You only integrate a frequency counter into your circuit in the form of a contact and enable coil. The coils and contacts have the following meanings:

Contact	Coil	Description
C15 to C16		The contact switches if the actual value is greater than or equal to the setpoint.
	CC15, CC16	Enable of the frequency counter on '1' state, coil activated.
	RC15, RC16	Reset, coil triggered: actual value reset to 00000.

IMPORTANT

The frequency counter can also be enabled specifically for a special operating state. This has the advantage that the cycle time of the device is only burdened with the frequency measurement when it is taking place. If the frequency counter is not enabled, the cycle time of the device is shorter.

Parameter Display and Parameter Set for Frequency Counter

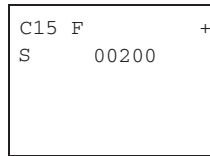

C15	Counter function relay number 15
F	Mode F: frequency counter
+	<ul style="list-style-type: none"> • + appears in the Parameter menu. • - does not appear in Parameter menu.
S	Setpoint, constant from 00000 to 01000 (32000 is a possible setting, the maximum frequency is 1 kHz).

In the parameter display of a counter relay you change the mode, the setpoint and the enable of the parameter display.

Value Range

The counter relay counts between 4 and 1000 (Hz).

Parameter display in Run mode:

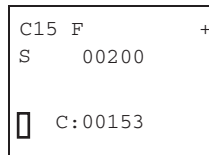

Current setpoint, constant

Contact has not switched.

Contact has switched. Actual value (0153)

Retention

Setting retention on the frequency counter serves no purpose since the frequency is continuously measured.

Function of the Frequency Counter

- 1: Counter input I3 or I4.
 - 2: Upper Setpoint.
 - 3: Enable coil CC...
 - 4: Reset coil RC...
 - 5: Contact (make contact) C... upper setpoint value reached.
- tg: Gate time for the frequency measurement.

- Range A: The counter is enabled. Contact C15 (C16) switches after a frequency above the setpoint was measured for the first time.
- Range B: If the actual value falls below the setpoint, the contact is reset. The removal of the enable signal resets the actual value to zero.
- Range C: The counter is enabled. After a frequency above the setpoint was measured for the first time, contact C15 (C16) switches.
- Range D: The reset coil resets the actual value to zero.

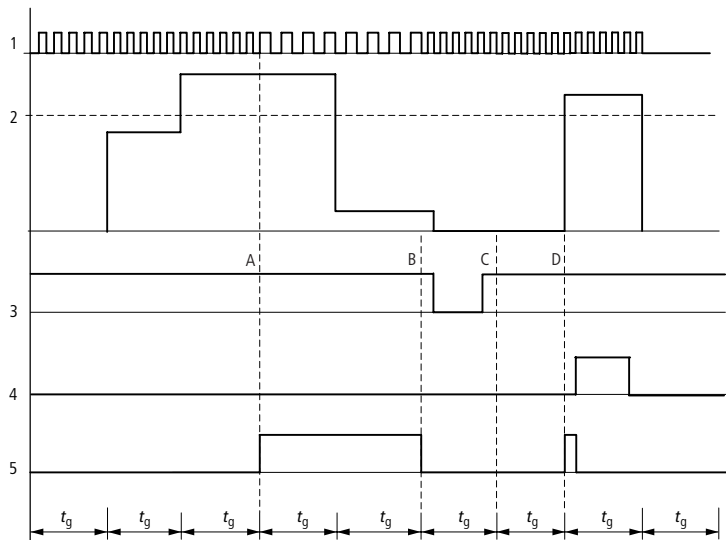

High Speed Counter

You can use the high-speed counters to count high frequency signals reliably.

Pico provides two high-speed up/down counters, C13 and C14, for use as required. The high-speed counter inputs are permanently connected to the digital inputs I1 and I2. These counter relays allow you to count events independently of the cycle time.

The high-speed counters allow you to enter an upper threshold value as a comparison value. The C13 and C14 high-speed counters are not dependent on the cycle time.

Counter Frequency and Pulse Shape

The maximum counter frequency is 1 kHz.

The signals must be square waves. We recommend a mark-to-space ratio of 1:1.

If this is not the case: The minimum mark-to-space ratio is 0.5 ms.

$$t_{min} = 0.5 \times \frac{1}{f_{max}}$$

t_{min} = minimum time of the pulse or pause duration

f_{max} = maximum count frequency (1 kHz)

IMPORTANT

High-speed counters operate independently of the program cycle time. The results of the actual value setpoint comparison is only transferred once every program cycle for processing in the circuit diagram. The reaction time in relation to the setpoint/actual value comparison can therefore be up to one cycle in length.

Wire a High-Speed Counter

The following assignment of the digital inputs apply.

- I1: High-speed counter input for counter C13.
- I2: High-speed counter input for counter C14.

IMPORTANT

If you use C13 or C14 as high-speed counters you must enable them with the coil CC13 or CC14 accordingly.

-----CC13
C13-----SN3
I6-----DC13
I8-C13-----RC13

You integrate a high-speed counter into your circuit in the form of a contact and coil.

The coils and contacts have the following meanings:

Contact	Coil	
C13 to C14		The contact switches if the actual value is greater than or equal to the setpoint.
	CC13, CC14	Enable of the high-speed counter on 1 signal coil activated.
	DC13, DC14	Counting direction: <ul style="list-style-type: none"> • Status 0, not activated, up counting. • Status 1, activated, down counting.
	RC13, RC14	Reset, coil triggered: Actual value reset to 00000.

IMPORTANT

The high-speed counter can also be enabled specifically for a special operating state. This has the advantage that the cycle time of the device is only burdened with the counting when it is taking place. If the high-speed counter is not enabled, the cycle time of the device is shorter.

Parameter Display and Parameter Set for the High-Speed Counter

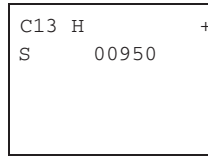

C13	Counter function relay number 13.
H	H - High-speed counter mode.
+	<ul style="list-style-type: none"> • + appears in the Parameter menu. • - does not appear in the Parameter menu.
S	Setpoint, constant from 00000 to 32000.

In the parameter display of a counter relay you change the mode, the setpoint and the enable of the parameter display.

Value Range

The counter relay is in Run mode.

Behavior When Value Range is Reached

The Pico control relay is in Run mode.

The value is retained if the counter reaches 32000. If the counter counts down and reaches 0, this value is retained.

Parameter display in Run mode:

C13 H +
S 00200

C:00877

Current setpoint, constant

Contact has not switched.

Contact has switched. Actual value (0153)

Retention

The high-speed counter can be run with the retentive actual value. You can select the retentive counter relays in the System menu by selecting Retention. C5 to C7, C8 and C13 to C16 can be selected.

If a counter relay is retentive, the actual value is retained when the operating mode changes from Run to Stop as well as when the power supply is switched off.

When Pico is restarted in Run mode, the counter relay continues with the retentively stored actual value.

- 1: Count pulses at counter input I1 (I2)
- 2: Setpoint of the counter.
- 3: Actual value of the counter.
- 4: Enable of the counter, CC13 (CC14).
- 5: Count direction, direction coil DC13 (DC14).
- 6: Reset coil of the counter RC13 (RC14).
- 7: Contact of the counter, C13 (C14).

- Range A: The relay contact C13 (C14) of the counter with setpoint value 512 switches as soon as the actual value is 512.
- Range B: When new count pulses or the counter enable is not present, the actual value is retained.
- Range C: If the count direction is reversed DC13 (DC14), the contact is reset when the actual value is 511.
- Range D: The count direction is set to 'up counting'.
- Range E: The Reset coil RC13 (RC14) resets the counter to 0. No pulses are counted.
- Range F: The Reset coil is not active; pulses are counted.

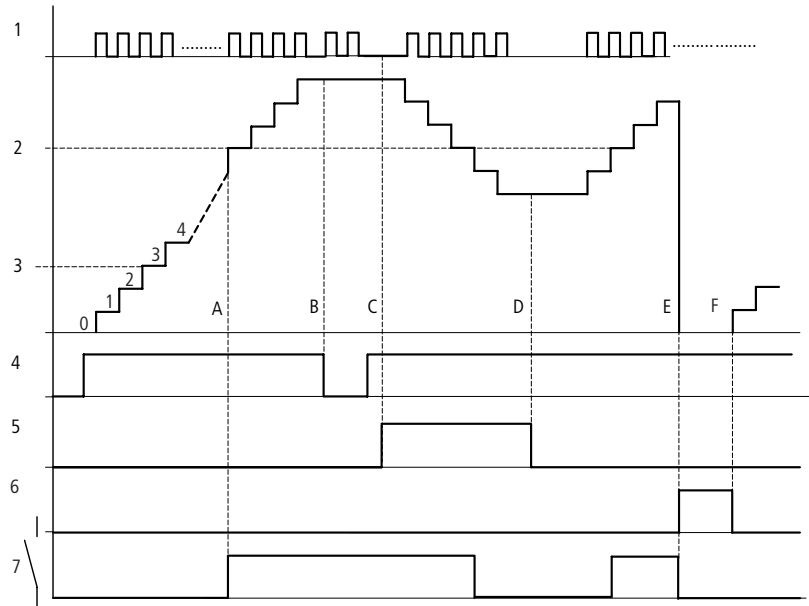

Time Switch

All versions of Pico are equipped with a real-time clock except the units with the '-NC' designation. The procedure for setting the time is described in Set Date, Time, and Daylight Saving Time on page 6-9.



Pico has 8 time switches, providing a total of 32 switching times.

Each time switch has four channels which you can use to set four on and off times. The channels are set via the parameter display.

The real-time clock has a back-up battery. This means that it continues to run in the event of a power failure, although the time switch relays do not operate. The technical data in Appendix A contains details on the battery back-up time.

TIP

If you wish to load an existing Pico Series A Controller circuit diagram, the existing time switch functions are retained. The Pico Series B Controller time switch operates in the same way as a Series A Controller.

Compatibility between Pico Series A Controllers and Pico Series B Controllers

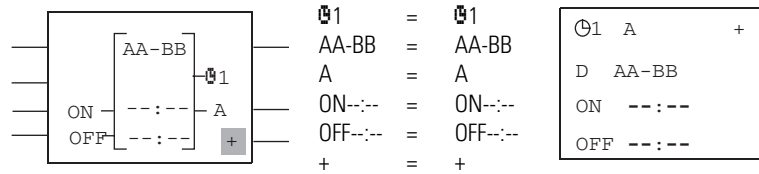

Parameters for Time Switch

A time switch has four sets of parameters, one for each channel (A, B, C and D). These are used to set the day of the week and the turn-on and turn-off times for the desired channels and to enable or disable parameter access. Changing the switching times is described in Chapter 7.

You can only change the '+'/'-' setting for displaying the parameters via the PARAMETER menu option when you are editing the circuit diagram.

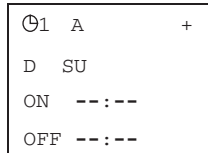

Ⓜ1	7-day time switch function relay 1.
A, B, C, D	Time switch channels
+	<ul style="list-style-type: none"> • + Appears in the Parameter menu. • - Does not appear in the Parameter menu.
D	Day setting, from -- to --.
ON	On time.
OFF	Off time.

The current time only appears in the parameter display in Run mode. Call up the parameter display in Run mode via the power flow display or via PARAMETER in the main menu.

Switch-On and Switch-Off Times

Parameter	Meaning	Valid Setpoint Times
Day of the week	Monday to Sunday	MO, TU, WE, TH, FR, SA, SU
On time	Hours: minutes: No time set: "--:--"	00:00 to 23:59, --:--
Off time	Hours: minutes: No time set: "--:--"	00:00 to 23:59, --:--

Parameter Set Displayed via the PARAMETER Menu Option

+ Access enabled	- Access disabled
------------------	-------------------

Example 1

Time switch 1 turns on Monday through Friday between 6:30 am and 9:00 am and between 5:00 pm and 10:30 pm.

⊖1 A +	⊖1 B +
D MO-FR	D MO-FR
ON 06:30	ON 17:00
OFF 09:00	OFF 22:30

Signal Diagram:

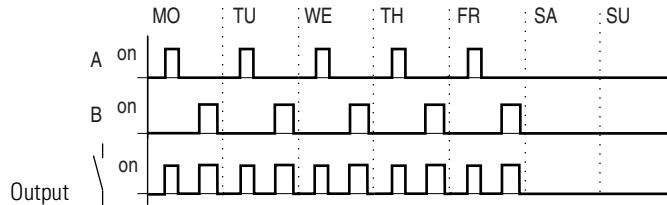

Example 2

Time switch 2 turns on at 4:00 pm on Friday and switches off at 6:00 am on Monday.

⊖2 A +	⊖2 B +
D FR	D MO
ON 16:00	ON --:--
OFF --:--	OFF 06:00

Signal Diagram:

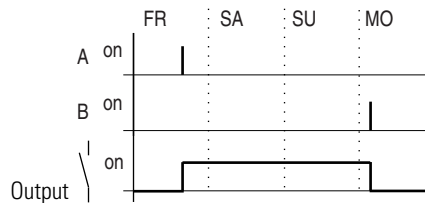

Example 3

Time switch 3 turns on overnight at 10:00 pm on Monday and switches off at 6:00 am on Tuesday.

⊖3 D	+
D	MO
ON	22:00
OFF	06:00

Signal Diagram:

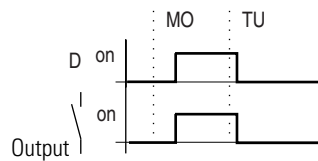

IMPORTANT

If the Off time is before the On time, Pico will switch off on the following day.

Example 4

The time settings of a time switch can overlap. The clock turns on at 4:00 pm on Monday, whereas on Tuesday and Wednesday it turns on at 10:00 am. On Monday to Wednesday the turn-off time is 10:00 pm.

⊖4 A	+	⊖4 B	+
D	MO-WE	D	TU-WE
ON	16:00	ON	10:00
OFF	22:00	OFF	00:00

Signal Diagram:

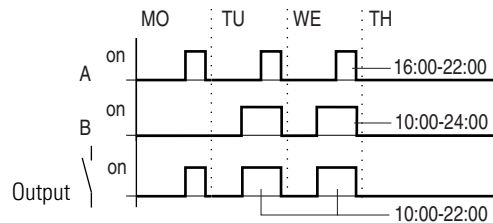

Turn-on and turn-off times always follow the channel which switches first.

Example 5

The power to Pico is removed between 3:00 pm and 5:00 pm. The relay drops out and remains off, even after the power returns, since the first switch-off time was at 4:00 pm.

⊖4 A	+	⊖4 B	+
D	MO-SU	D	MO-SU
ON	12:00	ON	12:00
OFF	16:00	OFF	18:00

When it is powered on, Pico always updates the switching state on the basis of all the available switching time settings.

Example 6

The time switch is to operate for 24 hours. Turn-on time at 0:00 on Monday and turn-off time at 0:00 on Tuesday.

⊖1 A	+	⊖1 B	+
D	MO	D	TU
ON	00:00	ON	--:--
OFF	--:--	OFF	00:00

Program a Time Switch

A time switch can be integrated into your circuit in the form of a contact. Use the parameter display to set the switch-on and switch-off times.

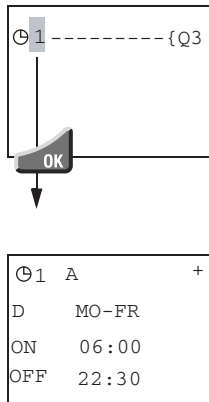

1. Enter the relay contact for the time switch in the contact field.
The cursor is over the contact number of the time switch.
2. Press Ok to set the switching times.
The parameter set for the first channel is displayed.
3. Set the switching times for the parameter set.

Analog Comparators

Analog comparators are only available with 12V dc and 24V dc models. An analog value comparator or threshold value switch enables you to compare analog input values with a setpoint, the actual value of another function relay or another analog input. This enables you to implement small controller tasks such as two point controllers very easily.

- The analog inputs of the 1760-L12 are I7 and I8.
- The analog inputs of the 1760-L18 and 1760-L20 are I7, I8, I11 and I12.

IMPORTANT

Compatibility with Pico Series A Controllers:

If you have loaded an existing Pico Series A circuit diagram, the previous comparator functions and values are retained. The analog value comparator function relay can work in Pico Series B Controllers in the same way as in Series A Controllers. The setpoints are converted to the new resolution of the analog inputs.

Pico provides sixteen analog comparators 'A1' to 'A16'.

A comparator can perform six different comparisons. The relay contact switches if the comparison conditions are true.



- I7 greater than or equal to I8, I7 less than or equal to I8
- I7 greater than or equal to setpoint, I7 less than or equal to setpoint
- I8 greater than or equal to setpoint, I8 less than or equal to setpoint

Both the setpoint value and the actual value correspond to the measured voltages.

The resolution of the voltage values from 0.0 to 10.0V dc is in 0.1V steps.

If the voltage at the input terminal is above 10V dc, the comparator value stays at 10.0V dc.

You can enter the setpoint values for a comparison while you are creating the circuit diagram or in the parameter display in Run mode.

A typical application would be to evaluate the analog values of sensors, e.g. to measure pressure or temperature.

A1	EQ	↑
I1	+0	
F1	+0	
I2	+0	↓
F2	+0	
OS	+0	
HY	+0	

Parameter Display

Parameter	Description
A1	Analog value comparator function relay 1.
EQ	Equal mode. The function relay has the following modes: <ul style="list-style-type: none"> • LT - less than • LE - less than/equal to • EQ - equal to • GE - greater than/equal to • GT - greater than
+	+ appears in the Parameter menu. - does not appear in the Parameter menu.
I1	Comparison value 1 (positive value I7, I8, I11, I12; actual value T1 to T16, C1 to C16).
F1	Gain factor for I1 ($I1 = F1 \times \text{actual value at I1}$); F1 = positive value from 0 to 9999.
I2	Comparison value 2 (positive value I7, I8, I11, I12; actual value T1 to T16, C1 to C16).
F2	Gain factor for I2 ($I2 = F2 \times \text{actual value at I2}$); F2 = positive value from 0 to 9999.
OS	Offset for the value of I1 ($I1 = OS + \text{plus actual value at I1}$); OS = positive value from 0 to 9999.
HY	Switching hysteresis for value I2. Value HY applies both to positive and negative hysteresis. <ul style="list-style-type: none"> • $I2 = \text{Actual value at I2} + HY$ • $I2 = \text{Actual value at I2} - HY$ • HY = Positive value from 0 to 9999.

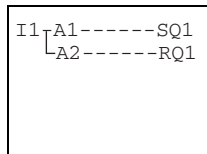

EXAMPLE

Analog comparator 'A1' latches (sets) relay Q1 if the actual value drops below the lower setpoint value of 7.1 V. Comparator 'A2' unlatches (resets) the relay if it rises above the upper setpoint value of 7.5 V. Thus, the difference (switching hysteresis) between the two voltage setpoint values is 0.4 V.

The parameter settings are:

A1	LE	↑
I1	+7.1	
F1	+0	
I2	+0	↓
F2	+0	
OS	+0	
HY	+0.4	

A2	GE	↑
I1	+7.1	
F1	+0	
I2	+7.5	↓
F2	+0	
OS	+0	
HY	+0.4	

Timing Diagram:

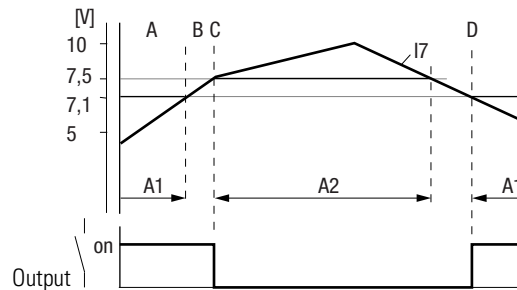

A1 sets relay output Q1 (A) up to a voltage of 7.1V. The hysteresis (B) is between 7.1V and 7.5V. At 7.5V, A2 causes the relay to reset (C). Q1 drops out and does not pick up again until A1 is set at 7.1V (D).

IMPORTANT Analog signals of sensors typically fluctuate by several millivolts. For stable set and reset switching, the setpoints should differ by at least 0.2V (switching hysteresis).

ATTENTION To prevent the uncontrolled switching of the relay coils only use the Set and Reset functions with the analog comparators.

Program Analog Comparators

You integrate an analog comparator into your program in the form of a contact. Use the parameter display to select one of six possible comparators and enter the setpoint values.

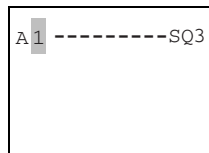

1. Enter the relay contact for the analog comparator in the contact field.

The cursor moves to the contact number of the comparator.

2. Press Ok to switch to the parameter display.

The parameter set for the first comparator is displayed.

3. Use the left and right arrows to move the cursor to the field greater than or equal to. Use the up and down arrows to select one of the comparator relays.

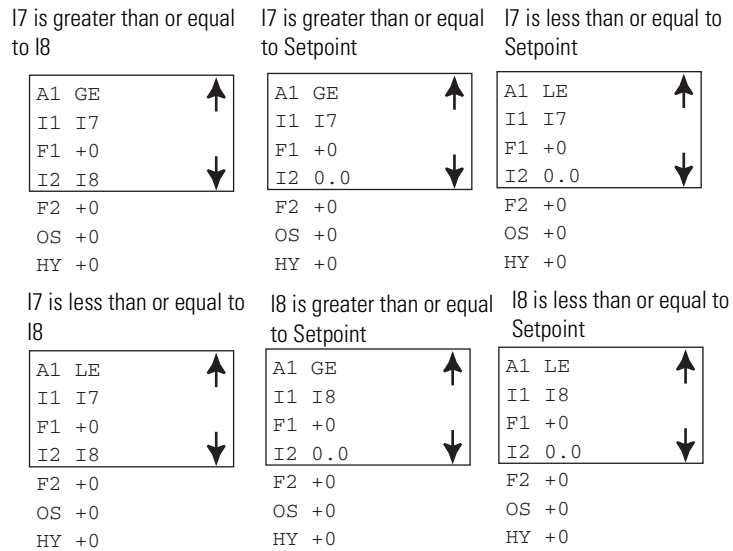

4. Press Ok to finish or enter another setpoint value. Press Esc to return to the circuit diagram display.

Text Display

Series B Pico controllers allow you to display sixteen user-defined text displays which can be edited in PicoSoft v.6.1 and higher. These texts can be triggered by the actual values of function relays such as timing relays, counters, operating hours counters, analog value comparators, date, time or scaled analog values. The setpoints of timing relays, counters, operating hours counters and analog value comparators can be modified when the text is displayed. The text displays are saved in the PicoSoft file or on the 1760-MM2B memory module.

If you need to load an existing 1760-18xxx, Series A circuit diagram, the available text display functions are retained. The text display in Series B controllers operates in the same way as in a Series A controller.

Example

Pico text display can be very useful!!

Circuit Diagram Elements Text Display

Contacts	Make Contact Break Contact	D \bar{D}
Numbers		1 to 8
Coils		D
Numbers		1 to 8
Coil functions		{, S, R \lrcorner

LCD Display

The LCD display can show up to 12 characters per line and up to 4 lines.

Variables

Actual values and setpoints of timing relays and counters, as well as the current time, can be displayed in lines 2 or 3, character positions 5 to 8 (character positions 5 to 9 for time display). If you have entered text at these locations, they will be overwritten by the variable values. Enter a blank space as the placeholder, in order to continue text after the variable display.

Function

The text display relays (D) function in the circuit diagram as normal output instructions. All eight text display relays can be used retentively.

If text is assigned to a text display, it will be displayed on the LCD if the coil is set to 1. For this to happen, Pico must be in Run mode and the status display must be showing before the text is activated.

The following conditions apply to D2 and D8:

When activating several text displays, they are displayed automatically every 4 s in succession. This process is repeated until:

- none of the display relays are set to 1
- stop mode is selected
- the Pico power is turned off
- the Ok or Del + Alt buttons are used to switch to a menu, or
- the text for D1 is displayed

The following applies to D1:

D1 is designed as an alarm text and takes precedence over all other text displays. If D1 is activated, the text assigned to it is displayed until:

- the coil D1 is reset to 0
- stop mode is selected
- the Pico power supply is switched off, or
- the Ok or Del + Alt buttons are used to switch to a menu

Text Entry

Text entry is only possible using PicoSoft version 2.1 and higher.

Character Set

All alphabetic characters in upper and lower case are allowed.

A B C D E F G H I J K L M N O P Q R S T U V W X Y Z
a b c d e f g h i j k l m n o p q r s t u v w x y z

The following special characters are also allowed:

! " # \$ % & ' () * + , - . / 0 1 2 3 4 5 6 7 8 9

Examples

Counter with actual value and setpoint

```

QUANTITY
QTY.0042
SETP0500 PCE
!COUNTING!
    
```

Analog values scaled as temperature values

```

TEMPERATURE
A  -010DEG.
I  +018DEG.
HEATING
    
```

D1 as error message on fuse failure

```

FUSE
FAULT
HOUSE 1
FAILED!
    
```

Jumps

The 1760-L18xxx allows the use of jumps. Jumps can be used to optimize the structure of a program or to implement the function of a selector switch. For example, jumps can be used to select whether manual/automatic operation or other machine programs are to be set.

Jumps consist of a jump location and a jump destination (label).

Circuit Diagram Symbols for Jumps

Contact (Can Only Be Used as First Leftmost Contact)	Make Contact	:
Numbers		1 to 8
Coils		{
Numbers		1 to 8
Coil function		{

Function

If the jump coil is triggered, the circuit connections coming directly after it are not processed. The states of the coils before the jump are retained, unless they are overwritten in circuit connections that were not missed by the jump. Jumps are always made going forward, i.e. the jump ends on the first contact with the same number as that of the coil.

- Coil = jump when 1
- Contact only at the first leftmost contact = Jump destination

The Jump contact point is always set to 1. Backward jumps are not possible with Pico. If the jump label does not come after the jump coil, the jump is made to the end of the circuit diagram. The last circuit connection is also skipped.

If a jump destination is not preset, the jump is made to the end of the circuit diagram.

Multiple use of the same jump coil and jump contact is possible as long as this is implemented in pairs, for example:

- Coil {1/jumped range/Contact:1
- Coil {1/jumped range/Contact:1 etc.

TIP

The states of jumped circuit connections are retained. The time value of timing relays that have been started will continue to run.

Power Flow Display

Jumped ranges are indicated by the coils in the power flow display. All coils after the jump coil are shown with the symbol of the jump coil.

- EXAMPLE** A selector switch allows two different sequences to be set.
- Sequence 1: Switch on Motor 1 immediately.
 - Sequence 2: Switch on Guard 2, Wait time, then switch on Motor 1.

Contacts and relays used:

Coil	Function
I1	Sequence 1
I2	Sequence 2
I3	Guard 2 moved out
I12	Motor-protective circuit-breaker switched on
Q1	Motor 1
Q2	Guard 2
T1	Wait time 30.00 s, on-delayed
D1	Text 'Motor-protective circuit-breaker tripped'

Circuit Diagram:

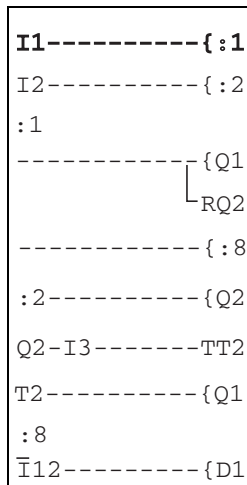

Power Flow Display: I1 selected:

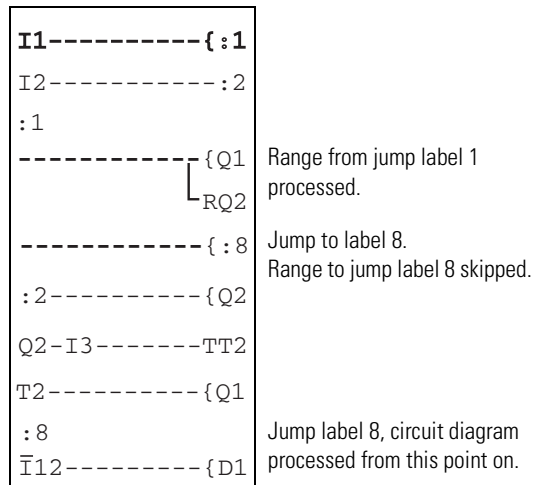

Example Programs

The Pico circuit diagram is created using ladder logic. This section contains a few programs intended to demonstrate possibilities for your own circuit diagrams.

The values in the logic table have the following meanings for contacts:

- 0 = make contact open, break contact closed
- 1 = make contact closed, break contact open

For relay coils Qx:

- 0 = coil not energized
- 1 = coil energized

Negation

Negation means that the contact opens, rather than closes, when it is actuated (NOT circuit).

In the Pico circuit diagram, press the Alt button to toggle contact I1 between break and make contact.

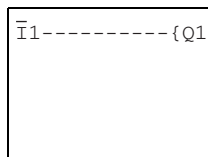

Logic Table

I1	Q1
1	0
0	1

Permanent Contact (Unconditional Rung)

To energize a relay coil continuously, make a connection of all contact fields from the coil to the leftmost position.

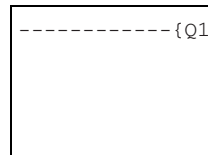

Logic Table

---	Q1
1	1

Series Connection

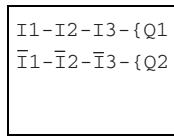

Q1 is controlled by a series circuit consisting of three make contacts (AND circuit).

Q2 is controlled by a series circuit consisting of three break contacts.

In the Pico circuit diagram, you can connect up to three make or break contacts in series within a circuit connection. Use 'M' marker relays if you need to connect more than three make contacts in series. (see page 4-10)

Logic Table

I1	I2	I3	Q1	Q2
0	0	0	0	1
1	0	0	0	0
0	1	0	0	0
1	1	0	0	0
0	0	1	0	0
1	0	1	0	0
0	1	1	0	0
1	1	1	1	0

Parallel Connection

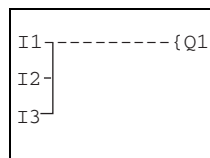

Q1 is controlled by a parallel circuit consisting of three make contacts (OR circuit).

A parallel circuit of break contacts controls Q2.

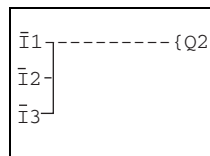

Logic Table

I1	I2	I3	Q1	Q2
0	0	0	0	1
1	0	0	1	1
0	1	0	1	1
1	1	0	1	1
0	0	1	1	1

Logic Table

I1	I2	I3	Q1	Q2
1	0	1	1	1
0	1	1	1	1
1	1	1	1	0

Exclusive OR Circuit

This circuit is made in Pico using two series connections that are combined to form a parallel connection (XOR).

XOR means that this circuit is an 'Exclusive OR circuit'. Only if one contact switches, can the coil be energized.

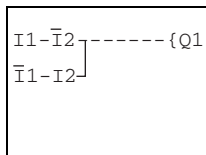

Logic Table

I1	I2	Q1
0	0	0
1	0	1
0	1	1
1	1	0

Motor Start/Stop Circuit

A combination of a series and parallel connection is used to wire a latching circuit.

Latching is established by contact Q1 which is parallel to I1. If I1 is actuated and reopened, the current flows via contact Q1 until I2 is actuated.

Logic Table

I1 Start	I2 Stop	Contact Q1	Coil Q1 Motor
0	0	0	0
0	1	0	0
1	1	1	1
0	1	1	1
1	0	0	0

S1 make contact on I1
S2 break contact on I2

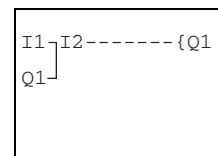

Latching circuits are used to switch machines on and off. The machine is turned on when the normally open push button connected to input terminal I1 is activated. The machine is turned off when the normally closed push button connected to I2 is activated.

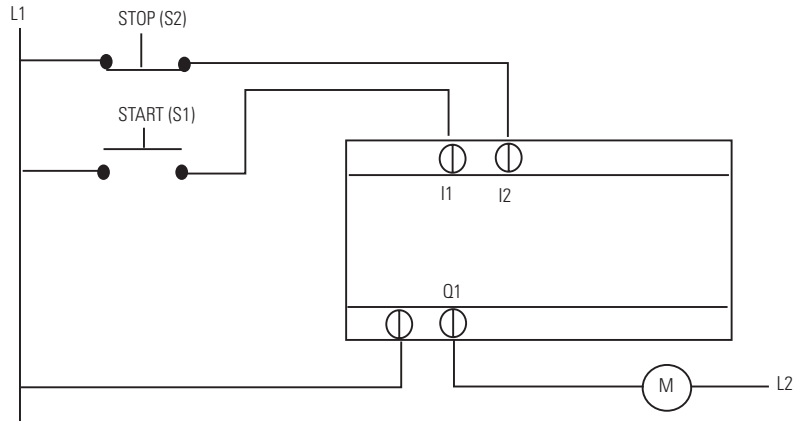

S2 opens the connection to the control voltage in order to turn off the machine. This ensures that the machine will be turned off, even in the event of a wire break.

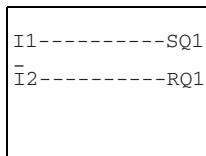

A self-latching circuit with wire break monitoring can alternatively be wired using the Set and Reset coil functions.

Relay Q1 is latched when I1 is turned on. I2 inverts the break contact signal from S2 and does not switch until S2 is actuated. In this way, the machine is switched off if a wire breaks.

Make sure that both coils are wired up in the correct order in the Pico circuit diagram: first wire the “S” coil and then the “R” coil. This means that the machine will be switched off when I2 is actuated, even if I1 is switched on.

Flip-Flop Relay

A flip-flop relay is often used for controlling lighting such as for staircase lighting. Press the push button wired to I1 once and the lights turn on. Press the push button again and the lights turn off.

Logic Table

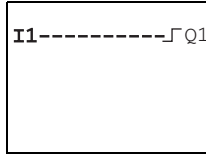

I1	State Q1	Q1
0	0	0
0 to 1	0	1
0	1	1
0 to 1	1	0

On-Delay Timing Relay

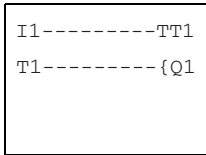

The on-delay can be used to gate short pulses or to initiate another movement after a time delay when a machine is started.

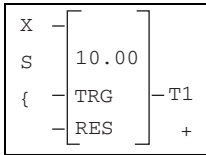

The parameter settings for T1 are:

- Timing function on-delayed: “x”
- Time value and range: 10 seconds

If I1 is switched on, the trigger coil (TRG) of T1 is energized. After 10 seconds, T1 turns on the output relay Q1. If I1 is switched off, relay coils T1 and Q1 drop out and the timer is reset.

Logic Table

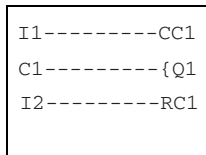

I1	T1	Q1
0	0	0
1	0	0
1	1	1

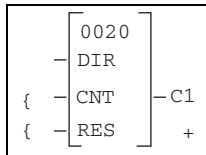

Count Up Counter

The count up counter keeps track of a given number of events. Once its preset number of counts is reached, the counter energizes an output. This can be used for keeping track of reject parts. Once the reject parts bin contains 20 parts, the bin is emptied by energizing an output. The counter is reset by a second input.

Each time I1 is energized, counter C1 adds one to its counter. I1 must be de-energized before C1 recognizes another count. When I1 has been energized 20 times, C1 turns on output Q1. When input I2 is energized, the C1 counter is reset by using the reset instruction (RC1).

4x Shift Register

You can use a shift register for storing an item of information, e.g. sorting parts into good and bad; two, three, or four transport steps further on.

A shift pulse and the value (0 or 1) to be shifted are needed for the shift register.

The shift register's Reset input is used to clear any values that are no longer needed. The values in the shift register pass through the register in the following order.

1st, 2nd, 3rd, 4th storage position.

Block diagram for the 4x shift register:

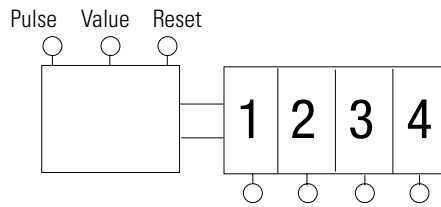

Function

Pulse	Value	Storage Location			
		1	2	3	4
1	1	1	0	0	0
2	0	0	1	0	0
3	0	0	0	1	0
4	1	1	0	0	1
5	0	0	1	0	0
Reset = 1		0	0	0	0

Assign the meaning 'bad part' to the value 0. This ensures that no bad parts will be reused if the shift register is accidentally deleted.

Item	Function
I1	Shift pulse (PULSE)
I2	Information (good/bad) to be shifted (VALUE)
I3	Delete content of the shift register (RESET)
M1	First storage position

If the relay coils were activated, Pico transfers the result to the contacts. M8 is now open once more. No new pulse can be generated until I1 is opened, since M7 is open for as long as I1 is closed. This is known as a 'One-shot' pulse.

How does the value reach the shift register?

When shift pulse M8 = 'on', the state of I2 (value) is transferred to storage position M1. If I2 is switched on, M1 is set. If I2 is switched off, M1 is cleared via break contact I2.

How is the result shifted?

Pico activates the coils in accordance with the circuit connection and its result, from top to bottom. M4 assumes the value of M3 (value 0 or 1) before M3 assumes the value of M2. M3 assumes the value of M2, M2 the value of M1 and M1 the value of I2.

Why are the values not constantly overwritten?

In this example, the coils are controlled only by the 'S' and 'R' functions, i.e. the values are retained in on or off states even though the coil is not constantly switched on. The state of the coil changes only if the circuit connection up to the coil is enabled. In this circuit, the marker relay is therefore either set or reset.

The circuit connections of the coils (storage positions) are only enabled via M8 for one cycle. The result of activating the coils is stored in Pico until a new pulse changes the state of the coils.

How are all the storage positions cleared?

When I3 is turned on, all the 'R'coils of storage positions M1 to M4 are reset, i.e. the coils are turned off. Since the reset was entered at the end of the circuit diagram, the reset function has priority over the set function.

How can the value of a storage position be transferred?

Use the make or break contact of storage positions M1 to M4 and program them to an output relay or in the circuit diagram according to the task required.

Running Light

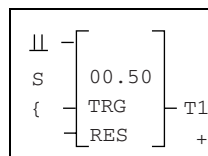

An automatic running light can be created by slightly modifying the shift register circuit. One output is always switched on. It starts at Q1, runs through to Q4 and then starts again at Q1. The marker relays for storage positions M1 to M4 are replaced by relays Q1 to Q4. The shift pulse I1 has been automated by the flasher relay T1. The cycle pulse M8 remains as it is.

On the first pass, the value is switched on once by break contact M9. If Q1 is set, M9 is switched on. Each output is turned on and off in sequential order (i.e. Q1, Q2, Q3, Q4). Pico changes state every second. Once Q4 (the last storage position) has been switched on, the value is passed back to Q1.

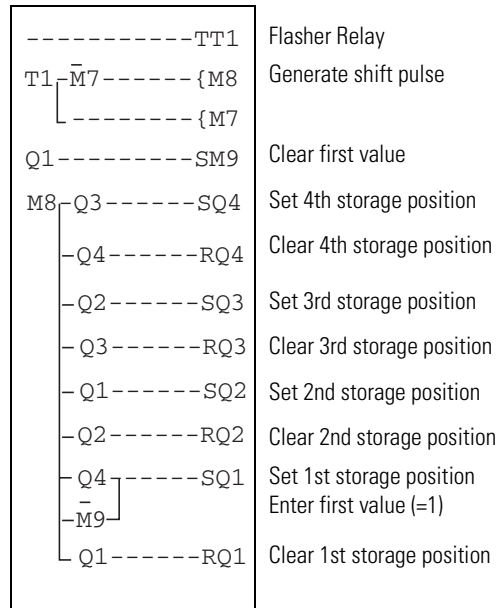

Stairwell Lighting

To save electricity, building maintenance wishes to keep the lights in a stairwell turned off unless someone is using the stairwell. The following program turns on the lights in the stairwell when a push button switch is pressed and released. Pressing the push button a second time turns off the lights. If the lights are not turned off manually, the Pico program turns them off after 6 minutes. If the push button is held for more than 2 seconds, the lights stay on continuously until someone presses the push button again.

The enhanced version of this program turns the lights off again after 4 hours if the push button was held for more than 2 seconds rather than leaving them on indefinitely.

Activation	Effect on Lighting
Button pressed briefly	Light ON or OFF. Lights turn off automatically after 6 minutes.
Button pressed for more than 2 seconds	Continuous lighting

Definition of the contacts and relays used:

Item	Function
I1	Button ON/OFF
Q1	Output Relay for light ON/OFF
M1	Marker relay. This is used to block the 'switch off automatically after 6 minutes' function for continuous lighting.
T2	Scan to determine how long the button was pressed. If pressed longer than 2 seconds, switch on continuous lighting (X, on delayed, value 2 seconds).
T3	Turn lights off after the light has been switched on for 6 minutes.
T4	Turn lights off after 4 hours continuous lighting (X, on-delayed, value 4:00 hours).

The Pico circuit diagram for the functions described above looks like this:

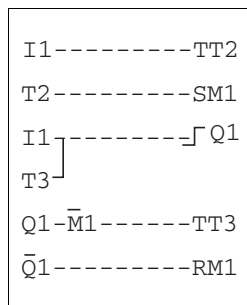

The enhanced Pico circuit diagram: after four hours, the continuous lighting is also switched off.

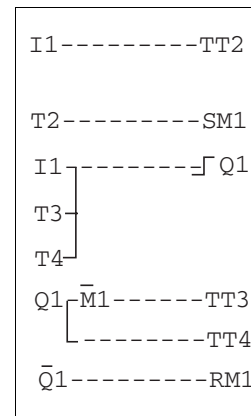

If you use Pico with a time switch, you can define both the stairwell lighting and the continuous lighting periods via the real time clock.

If you use Pico with analog inputs, you can optimize the stairwell lighting, via a brightness sensor to suit the lighting conditions.

Save and Load Circuit Diagrams

Interface to Memory Module and Programming Cable

The Pico controller has a covered interface. You can either use the Pico interface to save programs to a memory module or use PicoSoft programming software and the interface cable to transfer them to a PC.

A Pico controller without a display (1760-L1xxxx-ND) can be loaded with a program via PicoSoft or automatically from a memory module every time power is applied.

ATTENTION**ELECTRICAL SHOCK HAZARD**

The memory module and PC-cable socket are at the potential of L2. There is a danger of electric shock if L2 is not grounded. Do not make contact with electrical components under the socket cover.

Use a screwdriver to carefully remove the interface cover.

To close the interface, push the cover back onto the opening and snap it into place.

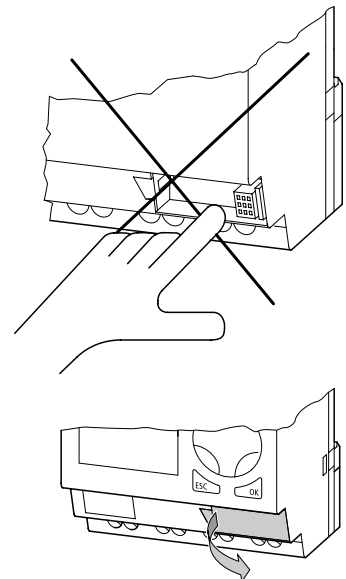

Memory Module

The following memory modules are available as Pico accessories.

Pico Controller	Memory Module
1760-L12xxx	1760-MM1 (Series A only)
1760-L18xxx	1760-MM2 (Series A only)
Series B Pico Controllers	1760-MM2B

Programs, including all relevant data, can be transferred from the 1760-MM2B memory module to the Series B Pico Controllers. The existing 1760-MM1 and 1760-MM2 memory modules are Read-Only when used with Series B Pico Controllers. The 1760-MM2B memory module will not work with Series A Pico Controllers.

Each 1760-MM2B memory module can hold one Pico program, up to 32K.

Information stored on the memory module is 'non-volatile'. Because the information is not lost when the power is turned off, you can use the module to make a backup copy of your program and/or to transfer it to another Pico device.

The following information is saved to the memory module:

- the program
- all parameter settings of the program
- all text displays
- system settings
 - debounce (input delay)
 - P-buttons
 - password
 - retention on/off

Insert the memory module into the open interface slot.

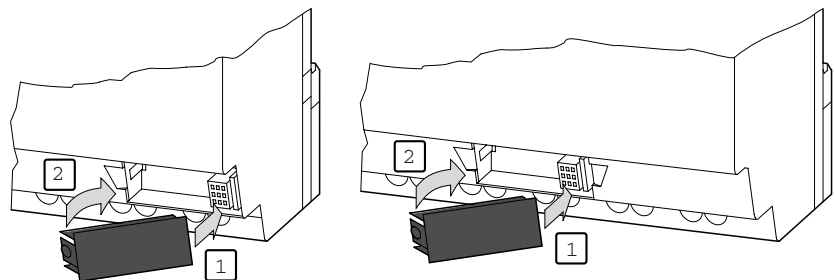

IMPORTANT

You can insert and remove the memory module even if power to Pico is on, without the risk of losing data.

Load or Store Programs

You can only transfer programs in Stop mode.

TIP

The no-display model, 1760-L1xxxx-ND, can be loaded with a program automatically from the memory module every time it is powered up. Simply insert a memory module into the interface of a 1760-L1xxxx-ND and apply power to the controller. Pico automatically reads the program from the memory module and goes into the RUN mode.

If the program in the memory module is not valid, the program already in the Pico unit is retained.

To transfer a program:

1. Switch to Stop mode.
2. Select PROGRAM... from the main menu.
3. Select the CARD... menu option.

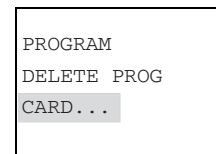

The CARD... menu option only appears if you have inserted a functional memory module.

You can transfer a program from Pico to the module, from the memory module to Pico, or you can delete the content of the memory module.

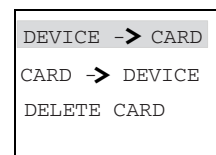
**IMPORTANT**

If the power fails during communication with the memory module, repeat the last procedure since Pico may not have transferred or deleted all the data.

After completing the operation, remove the memory module and close the cover.

Store a Circuit Diagram to the Memory Module

1. Select DEVICE-> CARD.
2. Confirm the prompt by pressing Ok. This deletes the contents of the memory module and replaces it with the program in Pico.
3. Press Esc to cancel.

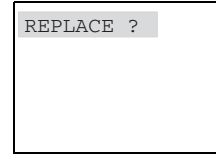

Load a Circuit Diagram from the Memory Module

1. Select the CARD-> DEVICE menu option.
2. Press Ok if you want to delete the Pico program and replace it with the memory module program.
3. Press Esc to cancel.

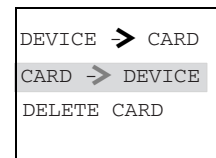

If a problem occurs during the operation, Pico displays the message "INVALID PROG".

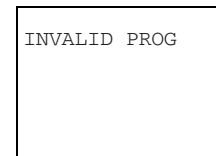

This either means that the memory module is empty or that the program in the memory module contains functions that Pico does not recognize.

- The time switch function relays only work with Pico versions with a real-time clock.
- The analog comparator function is only used with 12V dc and 24V dc versions of Pico.
- Text displays, jump and 'S' markers only work with the 1760-L18xxx.

IMPORTANT

If the memory module is password-protected, the password will also be transferred to the Pico memory and will be active immediately

Delete a Program from the Memory Module

1. Select the DELETE CARD menu option.
2. Press Ok to confirm the prompt and delete the card content.
3. Press Esc to cancel.

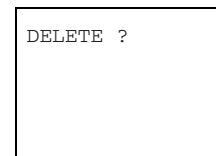

PicoSoft

PicoSoft and PicoSoft Pro are PC programs for creating, testing and managing Pico programs. You should only transfer data between the PC and Pico using the special PC interface cable, 1760-CBL-PM02, which is available as an optional accessory.

TIP

PicoSoft software is available at no charge from www.ab.com/pico. PicoSoft Pro software is a purchasable product for use with both Pico and Pico GFX controllers.

Software Compatibility

If you are using programming software to program the Pico controller, be sure that you are using the correct software version.

IMPORTANT

You must use PicoSoft version 6.1 or higher for the Series B Pico controller. Earlier versions of PicoSoft can only be used with Series A Pico controllers.

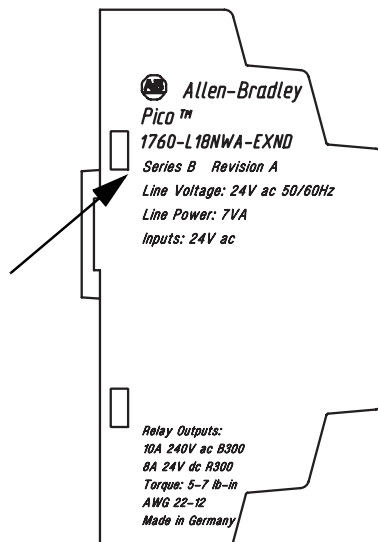

Find the Series Letter

The Series letter is printed on the side of the housing as shown.

Download the Software

You can download a free copy of PicoSoft version 6.1 from our web site. Go to <http://www.ab.com/picosoft6>.

To receive PicoSoft Pro, please contact your Allen-Bradley Distributor or Rockwell Automation representative.

Connect the Pico to the PC

ATTENTION



ELECTRICAL SHOCK HAZARD

Only use the 1760-CBL-PM02 cable with the Pico units. Use of another cable may place the user in danger of electrical shock.

1. Connect the PC cable to the serial PC interface.
2. Insert the Pico plug in the open interface.
3. Activate the status display on the Pico.

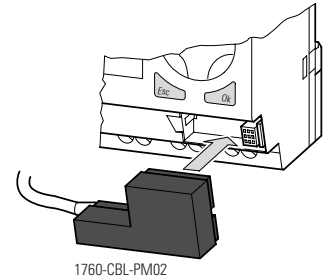

Pico cannot exchange data with the PC while in any other display mode.

Use PicoSoft to transfer circuit diagrams from your PC to Pico and vice versa. Switch Pico to Run mode from the PC to test and monitor the program.

If You Have Trouble

PicoSoft (catalog number 1760-PICOSOFT) provides extensive help on how to use the software.

To access the help, start PicoSoft and click on Help.

The on-line help provides all the additional information about PicoSoft that you will need.

If a problem occurs during transmission, Pico displays the message INVALID PROG.

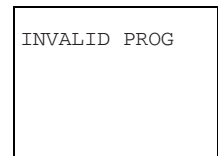

Check whether the circuit diagram contains a function that Pico does not recognize:

- The time switch function relays only work with Pico versions equipped with a real-time clock.
- The analog comparator function relay is only used with 12V dc and 24V dc Pico versions.
- Text displays, jump and 'S' markers only work with the 1760-L18xxx version.

IMPORTANT

If the power fails during communication with the PC, repeat the last procedure. All of the data may not have been transferred between the PC and Pico.

- After transmission, remove the cable and close the cover.

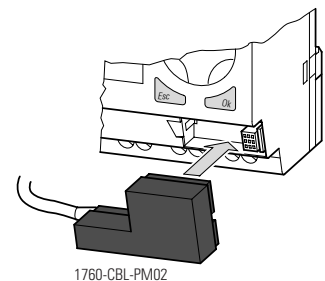

Pico System Settings

You can modify system settings on Pico models equipped with keypad and an LCD display, or by using PicoSoft (v2.1 and higher).

Password Protection

The Pico circuit diagram, function relay settings, and system parameters can be password protected.

In this case, the password consists of a value between 0001 and 9999. The number combination 0000 is used to delete a password.

Password protection blocks access to the circuit diagram menu and System menu and thus offers protection against the following:

- unauthorized modification of the circuit diagram
- modification of function relay parameters via the circuit diagram
- transfer of a circuit diagram from and to the memory module
- changing between operating modes Run or Stop.
- settings of the real-time clock
- communication with individual device
- switching off the password delete function
- modification of system parameters
 - set new password
 - Debounce (input delay) ON/OFF
 - P buttons ON/OFF
 - menu language selection

IMPORTANT

Only parameters marked with '-' are password-protected. Parameters marked with '+' can still be modified via the PARAMETER menu.

The password does NOT offer protection against access to the parameters of function relays marked with '+'.

IMPORTANT

A password that was entered in Pico is transferred to the memory module together with the circuit diagram, whether it was activated or not.

If this Pico circuit diagram is loaded from the memory module, the password is also transferred to Pico and is activated immediately.

Set the Password

Passwords can be set in the System menu in both Run or Stop operating modes. If, however, a password is already activated, you cannot change to the System menu.

1. Press Del and Alt to call up the System menu.
2. Select the menu item SECURITY... to enter the password.
3. Press the Ok button and move to the PASSWORD... menu.
4. Press the Ok button again to access the password entry area.

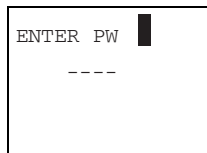

If a password has not been entered already, Pico will switch directly to the password display and show four dashes: no password set.

5. Press Ok, and four zeros appear.
6. Set the password using the cursor buttons:
 - left and right arrows move to the 4-digit entry field
 - left and right arrows select digit in password
 - up and down arrows set a value between 0 and 9.

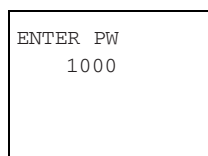

7. Save the new password by pressing Ok.

Pico will hide a valid password with XXXX.

8. Press Ok or Esc to exit the password display.

The password is now valid but not yet activated.

Select the Scope of the Password

1. Press Ok.

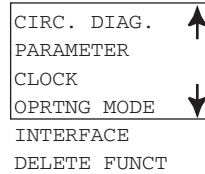

2. Select the function or menu to be protected.

3. Press Ok in order to protect the function or menu.

A check mark appears next to the protected item.

Standard protection encompasses the programs and circuit diagram. At least one function or menu must be protected.

- Circuit Diagram: The password is effective on the program with circuit diagram and non-enabled function relays.
- Parameter: The Parameter menu is protected.
- Clock: Data and time are protected with the password.
- Operating Mode: Switching between Run or Stop mode is protected.
- Interface: The interface is disabled for access with Pico software.
- Delete Function: The question Delete Prog? appears on the device after four incorrect password entries have been made. This prompt is not displayed if selected. However, it is no longer possible to make changes in protected areas if you forget the password.

Activate the Password

You can activate a valid password in three different ways:

- automatically when Pico is powered on again
- automatically after loading a protected circuit diagram from the memory module
- via the password menu

Use the following procedure to activate the password via the password menu.

1. Press Del and Alt to call up the System menu.

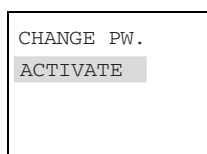

2. Open the password menu via the menu option 'PASSWORD...'.
Pico only shows this menu if a password is present.

IMPORTANT

Make a note of the password before you activate it. If the password entry is no longer known, Pico can still be unlocked. However, the circuit diagram and other settings are deleted.

ATTENTION



If the password is unknown or lost, and the password delete function is not activated, the unit can only be reset to the factory setting by the manufacturer. The programs and all data are lost.

3. Select 'ACTIVATE' and press Ok.

The password is now active. Pico automatically returns to the Status display.

You must unlock Pico using the password before you can carry out a protected function, enter a protected menu or the System menu.

Unlock Pico

Unlocking Pico deactivates the password. You can re-activate password protection later via the password menu or by switching the power off and on again.

1. Press Ok to switch to the main menu.

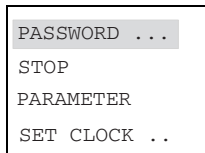

The "PASSWORD..." entry flashes.

2. Press Ok to enter password entry menu.

If Pico shows 'PROGRAM...' in the main menu instead of 'PASSWORD...', this means that there is no password protection active.

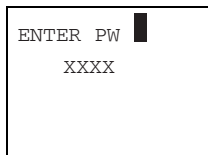

Pico displays the password entry field.

3. Enter the password using the cursor buttons.
4. Confirm with Ok.

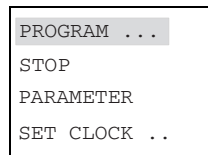

If the password is correct, Pico switches automatically to the Status display.

The 'PROGRAM...' menu item is now accessible so that you can edit your circuit diagram.

The System menu is also now accessible.

Change or Delete a Password

1. Press Del and Alt to call up the System menu.
2. Open the password menu by selecting Security and then Password from the System menu.

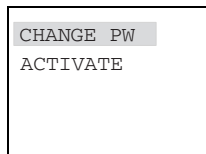

3. The CHANGE PW entry flashes.

Pico only shows this menu if a password is present.

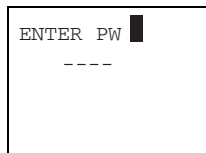

1. Press Ok to enter password entry menu.
2. Press Ok to move to the 4-digit entry field.
3. Use the left or right arrow to move to the 4-digit entry field.
4. Modify the four password digits using the cursor buttons.

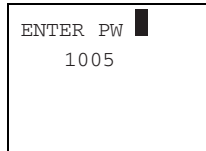

5. Confirm with Ok.
6. Press Esc to exit the password display.

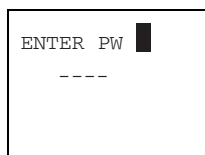

Delete a Password

Use the number combination 0000 to delete a password. If a password has not been entered already, Pico shows four dashes.

Password Incorrect or Not Known

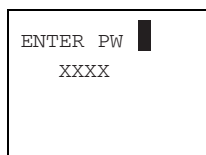

If you no longer know the exact password, you can try to re-enter the password several times.

After the fourth attempt, Pico asks whether you wish to delete the circuit diagram and data. Press:

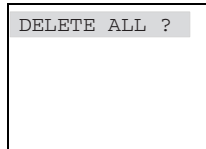

- Esc: Nothing is deleted. Pico is still password protected.
- Ok: Circuit diagram, data and password are deleted.

Pico returns to the Status display.

Pressing Esc retains the circuit diagram and data. You can then make another four attempts to enter the password.

Change the Menu Language

Pico Series B Controllers provide twelve menu languages. These can be set as required via the System menu.

Language	LCD display	Abbreviaton
English	ENGLISH	GB
German	DEUTSCH	D
French	FRANCAIS	F
Spanish	ESPANOL	E
Italian	ITALIANO	I
Portuguese	PORTUGUES	–
Dutch	NEDERLANDS	–
Swedish	SVENSKA	–
Polish	POLSKI	–
Turkish	TURKCE	–
Czech	CESKY	–
Hungarian	MAGYAR	–

Language selection is only possible if Pico is not password-protected.

1. Press Del and Alt to call up the System menu.
2. Select language as required to modify the menu language.

The language selection for the first entry ENGLISH is displayed.

ENGLISH	↑
DEUTSCH	
FRANCAIS	
ESPANOL	↓
ITALIANO	
PORTUGUES	
NEDERLANDS	
SVENSKA	
POLSKI	
TURKCE	
CESKY	
MAGYAR	

1. Use up or down arrows to select the new menu language, e.g. Italian (ITALIANO).
2. Confirm your entry with Ok. Pico shows a check mark next to the new menu language.
3. Press Esc to return to the status display.

Change Parameters

Pico allows you to change function relay parameters such as timer and counter setpoints without having to call up the circuit diagram. This is possible regardless of whether Pico is running a program or is in Stop mode.

1. Press Ok to switch to the main menu.
2. Start the parameter display by selecting PARAMETER.

```
T3 Л    S +
T8 X    M:S +
C4 N    +
O3      +
O2      +
A1 EQ   +
A3 LT   +
```

A complete parameter set is shown. In the example, these are the parameters for a timing relay T1.

The following requirements must be fulfilled for a parameter set to be displayed:

- A function relay must have been included in the circuit diagram.
- The parameter set has been enabled for access, indicated by the '+' character at the bottom right of the display.

Use the PARAMETER menu to access and modify accessible parameter sets. Parameter sets for which access is not enabled are not displayed. Pico therefore allows you to protect parameters with the use of a password. You can enable or disable parameter access using the parameter '+' or '-' characters respectively in the circuit diagram.

```
T3 Л    S +
I1 02.030
I2 05.000
T:
```

1. Use up or down arrows to scroll through the parameter sets. The cursor must be located on the identifier of the function relay, in this case T3.
2. Press Ok.
3. Use up or down arrows to select the parameter required.
4. Change the values for a parameter set:
 - press Ok to enter the Entry mode.
 - use left and right arrows to change decimal place.
 - use up and down arrows change the value of a decimal place
 - Ok Save parameter or Esc Retain previous setting.
5. Press Esc to leave the parameter display.

The parameter display is opened via the PARAMETER menu. '{' coil terminals for counters and timers are not displayed here, even if they have been programmed.

Variable Parameters for Function Relays

You can modify the relay parameters used in the circuit diagram in three different ways:

- All circuit diagram parameters can be adjusted in Stop mode via the circuit diagram.
- Setpoints can be modified in Run mode via the circuit diagram.
- Setpoints can be modified via the PARAMETER menu.

The following setpoints can be modified

- The timer setpoints for timing relays
- The counter setpoints of counter relays
- The day and ON/OFF times of time switches
- The comparison setpoint of analog comparators.

In Run mode, Pico operates with a new setpoint as soon as it is modified in the parameter display and saved.

Example: Modify Switching Times for Outside Lighting

The outside lighting of a building is automatically switched on from 19:00 to 23:30 (7:00 pm to 11:30 pm) Mondays to Fridays in the Pico program.

⊖1	A	15:21	+
D		MO-FR	
ON		19:00	
OFF		23:30	

The parameter set for the time switch function relay 1 is saved in channel 'A' and looks like this.

The outside lighting is now required to also turn on between 19:00 and 22:00 on Saturdays.

1. Select PARAMETER from the main menu.

The first parameter set is displayed.

2. Use up or down arrows to scroll through the parameter sets until channel A of time switch 1 is displayed.

⊖1	B	15:21	+
D		--	
ON		00:00	
OFF		00:00	

3. Press the up arrow to select the next empty parameter set, in this case channel B of time switch 1.

The current time is 15:21.

```

⊖1 B 15:21 +
D   SA
ON  00:00
OFF 00:00

```

4. Change the value for the day interval from MO to SA:
 - Left and right arrows move between the parameters
 - Up and down arrows change value.
 - Press Ok to save.

```

⊖1 B 15:21 +
D   SA
ON  19:00
OFF 00:00

```

5. Set the switching on time to 19:00.
6. Set the switching off time to 22:00.
7. Press Ok.

```

⊖1 B 15:21 +
D   SA
ON  19:00
OFF 22:00

```

- Pico saves the new parameters. The cursor remains in the contact field on channel identifier 'B'.
8. Press Esc to leave the parameter display.

The time switch will now also turn on at 19:00 on Saturdays and switch off at 22:00.

Set Date, Time, and Daylight Saving Time

If the clock is not set yet or if Pico is powered on after the battery backup time has been exceeded, the clock starts with the setting SA 0:01 01.05.2004. The Pico clock operates with date and time so the hour, minute, day, month and year must all be set.

```

SET CLOCK
SUMMER TIME

```

TIP

Pico uses military time, so 1:00 p.m. is 13:00, 7:30 p.m. is 19:30, etc.

```

HH:MM: 18:24
DD.MM: 01.05
YEAR : 2004

```

1. Select SET CLOCK from the main menu.

This opens the menu for setting the time.
2. Select SET CLOCK and press Ok.
3. Set the values for day, time, month and year.
 - Left and right arrows move between the parameters
 - Up and down arrows change the value of a parameter
4. Press Ok to save the day and time or Esc to retain the previous setting
5. Press Esc to leave the time setting display.

Change Between Winter/Summer Time (Daylight Saving Time)

The clock can be toggled between winter and summer time (daylight savings time) using the cursor buttons.

1. Select SET CLOCK from the main menu.

This opens the menu for setting the time.

2. Select menu item WINTER TIME or SUMMER TIME as required.

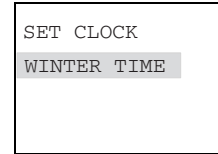

Change to Winter Time

Pico displays SUMMER TIME as the next possible option if winter time is already set.

Otherwise select WINTER TIME and press Ok.

Pico sets the clock one hour back, e.g. from 17:43 Sunday to 16:43 Sunday. The display then shows SUMMER TIME.

Change to Summer Time

Select SUMMER TIME and press Ok.

Pico sets the clock one hour forward, e.g. from 12:30 Wednesday to 13:30 Wednesday.

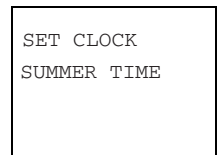

The display then shows WINTER TIME.

The weekday is not changed automatically with the time. If you change the time around midnight you must change the weekday as well.

Activate Debounce (Input Delay)

Input signals can be evaluated by Pico with a debounce delay. This enables the trouble-free evaluation of switches and push-buttons subject to contact bounce.

In many applications, however, very short input signals have to be monitored. In this case, the debounce function can be turned off.

1. Press Del and Alt to call up the System menu.
2. Select the System menu. If Pico is password-protected you cannot open the System menu until you have removed the password.
3. Set the Debounce mode using the menu items DEBOUNCE OFF/ DEBOUNCE ON.

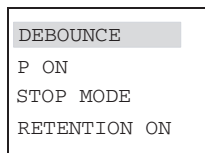

Deactivate Debounce (Input Delay)

If Pico is showing DEBOUNCE in the display, this means the Debounce mode is deactivated. Otherwise, select DEBOUNCE and press Ok.

If Debounce mode is deactivated, the display shows DEBOUNCE with no check mark.

Activate Debounce (Input Delay)

If there is a check mark next to DEBOUNCE, the Debounce function has been activated.

If there is no check mark, select DEBOUNCE and press Ok.

Press Esc to return to the status display. See Delay Times for Inputs and Outputs on page 8-7 for information on how Pico input and output signals are processed internally.

Activate and Deactivate P-Buttons

Even though the cursor buttons (P-Buttons) have been set as push-button inputs in the program, this function is not activated automatically. This prevents any unauthorized use of the cursor buttons. The P-Buttons can be activated in the System menu. If Pico is password-protected, you cannot open the System menu until you have unlocked Pico.

The P-Buttons are activated and deactivated via the P BUTTONS menu option.

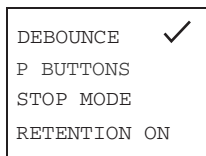

1. Press Del and Alt to select the System menu.
2. Select the SYSTEM menu.
3. Move to the 'P' menu option

Activate the P-Buttons

If Pico is showing P BUTTONS ✓, this means that the P-Buttons are active.

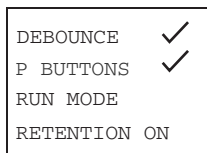

1. Otherwise, select P BUTTONS and press Ok.

A check mark appears and the P-Buttons are now active.

2. Press Esc to return to the status display.

The P-Buttons are only active in the Status display. In this display, you can use the P-Buttons to activate inputs in your circuit diagram.

Deactivate the P-Buttons

Select P BUTTONS and press Ok. The check mark is removed.

The P-Buttons are now deactivated. The P-Buttons are automatically deactivated when deleting a circuit diagram in Pico.

Start-Up Behavior

The start-up behavior is an important feature during the commissioning phase. The circuit diagram which Pico contains may not be completed or the system or machine may be in a state which Pico is not permitted to control. The outputs should not be activated when Pico is powered on.

Set the Start-Up Behavior

Pico models without a display can only be started in Run mode.

Requirement: Pico must contain a valid circuit diagram.

Enter the System menu. If Pico is protected by a password, the System menu is not available until Pico is unlocked (see Unlock Pico on page 6-4).

Specify in which operating mode Pico should start when power is applied. MODE: RUN/STOP is a toggle menu. The menu always displays the operating mode into which you can change.

Activate RUN Mode

DEBOUNCE	✓
P BUTTONS	
RUN MODE	✓
CARD MODE	

The default setting for Pico is displayed as RUN MODE ✓. In other words, Pico starts in Run mode when the power is applied.

If there is no check mark next to RUN MODE, select RUN MODE from the menu and press Ok. Press Esc to return to the status display.

DEBOUNCE	✓
P BUTTONS	
RUN MODE	✓
CARD MODE	

Deactivate RUN Mode

Select RUN MODE[✓] from the menu and press Ok. The RUN MODE is deactivated.

Start-Up Behavior	Menu Displayed	Status of Pico After Start-Up
Pico begins in Stop mode	RUN MODE	Pico is in Stop mode
Pico begins in Run mode	RUN MODE [✓]	Pico is in Run mode

Behavior When the Circuit Diagram is Deleted

The setting for the start-up behavior is a Pico device function. When the circuit diagram is deleted, this does not result in the loss of the setting selected.

Behavior During Upload and Download

When a valid circuit diagram is transferred from Pico to a memory module or the PC or vice versa, the setting is still retained. Pico controllers without a display can only be started in Run mode.

Possible Faults

Pico will not start in Run mode if:

1. Pico does not contain a circuit diagram.
2. You have put Pico in Stop mode (Run Mode menu displayed).

Card Startup Behavior

The startup behavior with memory module is for applications where unskilled personnel change the memory module under no-voltage conditions.

Pico only starts in the Run Mode if a memory module with a valid program is inserted.

If the program on the memory module is different than the program in Pico, the program from the card is loaded into the processor and the processor starts in the RUN mode.

Switch to the System menu.

If Pico is protected by a password, the System menu is not available until Pico is unlocked (see the section Unlock Pico on page 6-4).

Activation of Card Mode

If Pico displays Card Mode \checkmark , this means that when the power supply is switched on, Pico will only start in Run mode if a memory module with a valid program has been inserted.

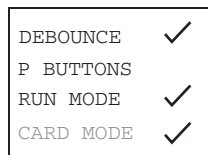

1. Otherwise select Card Mode and press Ok.

Pico will start up with the program on the card.

2. Press Esc to return to the Status display.

Deactivation of Card Mode

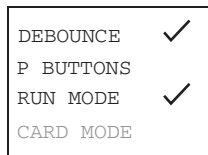

1. Select Card Mode \checkmark .

2. Press Ok.

The Card Mode function is deactivated.

The Pico default setting is for display of the Card Mode menu, i.e. Pico starts in Run Mode without the memory module when the power is switched on.

Set Cycle Time

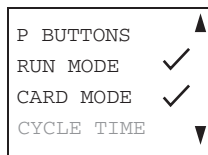

Pico allows you to set the cycle time. The default setting is 00 ms. Cycle time can only be set while Pico is in Stop mode.

1. Move to the System menu.
2. Select Cycle Time and press Ok.

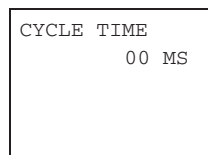

The following menu appears.

3. Press Ok.

4. Enter cycle time.

<p>CYCLE TIME 35 MS</p>

Use left and right arrows to move between parameters. Use up and down arrows to change the value.

5. Press Ok to save value.

The minimum set cycle time is 35 ms. The range is between 00 ms and 60 ms. The cycle time can be lengthened if Pico requires more time to process the program.

The entry of a set cycle time is only useful in applications involving two-step controllers or similar functions.

With a cycle time setting of 00 ms, the Pico processes the circuit diagram and the program at the fastest possible speed.

Retention

It is a requirement of system and machine controllers for operating states or actual values to have retentive settings. What this means is that the values will be retained safely even after the supply voltage to a machine or system has been switched off. The values are also retained until the next time the actual value is overwritten.

The following operands and function blocks can be set to operate retentively:

- Markers
- Counter function blocks
- Data function blocks
- Timing relays

Set Retentive Behavior

Requirement: Pico must be in Stop mode.

1. Switch to the System menu.

IMPORTANT

If Pico is protected by a password, the System menu is not available until Pico is unlocked (see the section Unlock Pico on page 6-4).

The default setting of Pico is for no retentive actual value data to be selected. When Pico is in Stop mode or has been switched to a de-energized state, all actual values are cleared.

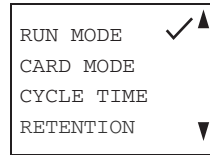

2. Switch to Stop mode.
3. Switch to the System menu.
4. Proceed to the SYSTEM menu and continue to the RETENTION... menu.
5. Press the Ok button.

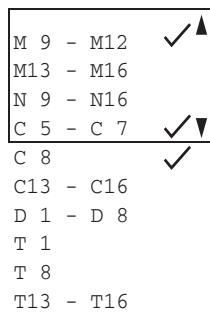

The next screen display is the selection of the marker range.

6. Use the up and down arrows to select a range.
7. Press Ok to select the marker, the function relay or the range that is to be retentive (check mark next to it).
8. Press Esc to exit the entry for the retentive ranges.

Delete Retentive Actual Values

The retentive actual values are cleared when (applies only in Stop mode):

- the circuit diagram is transferred from PicoSoft or the memory card to the Pico control relay, the retentive actual values are reset to zero. This also applies when there is no program on the memory card. In this case the old circuit diagram is retained.
- the selected retentive markers, function relays or text display are deactivated.
- the circuit diagram is deleted via the Delete Funct menu.

The operating hours counters are always retentive. The actual values can only be reset through a special reset operation from the circuit diagram.

Transfer of Retentive Behavior

The setting for retentive behavior is a circuit diagram setting; in other words, the retention setting is on the memory card and is transferred with the circuit diagram when uploading or downloading from the PC.

Change the Operating Mode or the Circuit Diagram

When the operating mode is changed or the circuit diagram is modified, the retentive data is normally saved together with the actual values. The actual values of relays no longer being used are also retained.

Change the Operation Mode

If you change from Run to Stop and then back to Run, the actual values of the retentive data are retained.

Modify the Circuit Diagram

If a modification is made to the circuit diagram, the actual values are retained.

ATTENTION

Even if the markers and function relays that were retentive are deleted from the circuit diagram, the retentive actual values remain when changing from Stop to Run, and when switching the device off and on. Should these relays be used again in the circuit diagram, they will still have their former actual values.

Change the Startup Behavior in the System Menu

The retentive actual values will be retained regardless of the Run mode or Stop mode settings.

Display Device Information

Device information is provided for service tasks and for determining the capability of the device concerned.

This function is only available with devices featuring a display.

The device enables the display of the following device information:

- AC or DC power supply.
- T (transformer output) or R (relay output).
- C (clock provided).
- A (analog output provided).
- LCD (display provided).
- Pico-Link (Pico-Link provided).
- OS: 1.10.204 (operating system version).
- CRC: 25825 (checksum of the operating system).

1. Switch to the main menu.

IMPORTANT

The device information is always available.
The password does not prevent access.

2. Select the main menu.

3. Use the down arrow to select the INFO... menu.

4. Press Ok.

This displays all device information.

5. Press Esc to exit the display.

Retention

What is Retention?

Some system and machine controllers for operating states or actual values require retentive settings. What this means is that values are retained even after power to a machine or system has been turned off and are retained until the actual value is overwritten.

Pico Models with Data Retention

Retentive values can be set with 1760-L12BWB-xx and 1760-L12DWD-xx (via the SYSTEM menu) as well as 1760-L18xxx for the following markers and function relays.

Retentive Markers and Function Relays

It is possible to retentively store (non-volatile memory) the actual values (status) of markers, timing relays, and up/down counters. The following markers and function relays can be set to have retentive actual values:

1760-L12BWB-xx, 1760-L12DWD	
Marker Relays	M13, M14, M15, M16
Timing Relay	T8
Up/Down Counter	C8
1760-L18xxx	
Markers	M13, M14, M15, M16
Text Function Relays	D1 through D8
Timing Relays	T7, T8
Up/Down Counters	C5, C6, C7, C8

The Retention setting applies to all of the relays listed above. Individual markers or function relays cannot be set retentively.

TIP

The retentive data is written to an EEPROM every time the power is turned off. Data security is thereby assured for 100,000 power cycles.

Set Retention

Requirement: Pico must be in Stop mode

Switch to the System menu. If Pico is protected by a password, the System menu is not available until Pico is unlocked (see Unlock Pico on page 6-4).

Enable the Retention function (see figure on previous page). The menu item RETENTION ON/OFF is a toggle menu. The menu always displays the operating mode into which you can change.

The default setting of Pico is the display RETENTION ON. With this setting, Pico runs without retentive data, provided a valid circuit diagram is present. When Pico is in Stop mode or has been switched to a de-energized state, all actual values are deleted.

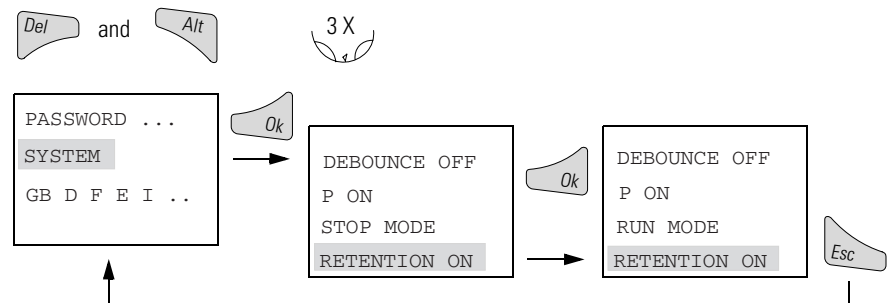

Retentive Behavior	Menu Displayed	Behavior: M13, M14, M15, M16, C8, T8, (D1 to D8, C5, C6, C7, T7) When the Unit is Switched Off and On Again
No retentive actual values	RETENTION ON	All actual values will be cleared when the unit changes from Run to Stop mode or when power is turned off.
Retentive actual values	RETENTION OFF	All actual values will be stored when the unit changes from Run to Stop mode or when power is turned off.

Delete Retentive Actual Values

The retentive actual values are cleared when (applies only to Stop mode):

- the circuit diagram is transferred from PicoSoft (PC) or from the memory module to Pico, the retentive actual values are reset to 0 (marker = off). This also applies when there is no program in Pico.
- there is a changeover from retention enabled (the display shows RETENTION OFF) to retention disabled (the display shows RETENTION ON).
- the circuit diagram is deleted via the DELETE PROG menu.

Transfer Retentive Behavior The setting for retentive behavior is a circuit diagram setting; in other words, the setting of the retention menu may also under certain circumstances be transferred to the memory card or during uploading or downloading from the PC.

Circuit Diagram Transfer (Behavior)

1760-L12BWB-xx, 1760-L12DWD-xx and 1760-L18xxx → Memory Module

When transfer is in this direction, the actual values are retained in Pico. The retention setting is transferred to the card.

1760-L12BWB-xx, 1760-L12DWD-xx and 1760-L18xxx → PicoSoft

The Pico circuit diagram is stored. The actual values are retained in Pico. All Pico circuit diagram settings are transferred to the 'EAS' file.

PicoSoft → 1760-L12BWB-xx, 1760-L12DWD-xx and 1760-L18xxx

The transfer to PicoSoft is carried out according to the relevant settings.

Change the Operating Mode or the Circuit Diagram

When the operating mode is changed or the Pico circuit diagram is modified, the retentive data is normally saved together with the actual values. The actual values of relays no longer being used are also retained.

Change the Operating Mode

If you change from Run to Stop and then back to Run, the actual values of the retentive data are retained.

Modify the Pico Circuit Diagram

If a modification is made to the Pico circuit diagram, the actual values are retained.

TIP

Even when the retentive relays M13, M14, M15, M16 (D1 to D8) and the function relays C8, T8 (C5, C6, C7, T7) are deleted from the circuit diagram, the retentive actual values are retained after the changeover from Stop to Run as well as after the power is switched off and on. Should these relays be used again in the circuit diagram, they still have their former actual values.

Change the Start-Up Behavior in the SYSTEM Menu

The retentive actual values in Pico are retained irrespective of the MODE RUN or MODE STOP settings.

Retentive Auxiliary Relays (Markers)

How the Retention Works

The retentive markers M13, M14, M15, M16, D1 to D8 should be used in conjunction with the following coil functions.

Instruction Type	Representation in Pico
Set	S M..., D...
Impulse Relay	 M..., D...
Reset	R M..., D...

TIP

When the condition for resetting the marker is satisfied, the marker is reset.

It is essential that you note the following points:

- When retention is used, the open or closed status of a retentive marker is remembered when power is disconnected. When power is restored, the marker assumes the same state, even if the conditions that would have changed its state occurred while the power was disconnected. If the conditions have changed, the state of the marker will reflect the change following the first program cycle after power is restored. This may result in the flicker or chatter of a lamp, solenoid, or quick responding load.
- Retention is useful for remembering that an event has occurred, like a latch or flip-flop. On the other hand, a conventional relay responds continuously to the electrical conditions at its coil. For this reason, the output energize function (i.e. {M13}) is not recommended in combination with the retentive markers M13 to M16 and D1 to D8.
- Because of retention, the following coil functions are not recommended: {M13 to {M16 and {D1 to {D8
- Be sure to pay close attention to the example circuits for the individual coil functions.

Examples

S/R Coil (Break Contact)

Task:

In your application you need to remember whether a screw was inserted or not. When your machine powers up, it is important that a screw that has already been screwed in place is not screwed in again - otherwise there could be permanent damage to the workpiece.

Contacts and relays used:

Coil	Function
I3	Screw detected
Q2	Enable pulse to drive screw
M8	Enable screw command
M14	Screw present (retentive)
M9	Workpiece transported away, reset M14

Circuit diagram (part):

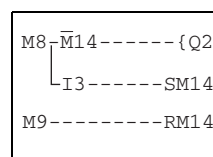

Signal diagram:

The 'Make Contact' state is always displayed in the Signal diagram.

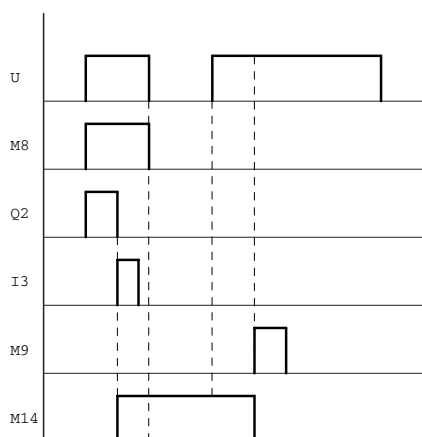

U = Supply voltage

The break contact of the retentive marker M14 is used. No enabling time is required for output Q2.

Impulse Relay

Task:

After a power failure, the lights in a stairwell should resume their previous state.

Contacts and relays used:

Coil	Function
T2	Enable after first cycle
I1	Push-button
Q1	Lamp output
M15	Impulse relay (retentive)

Circuit Diagram:

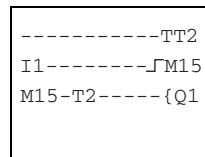

Parameter Display:

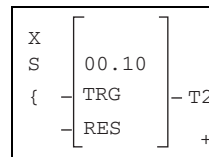

Signal diagram:

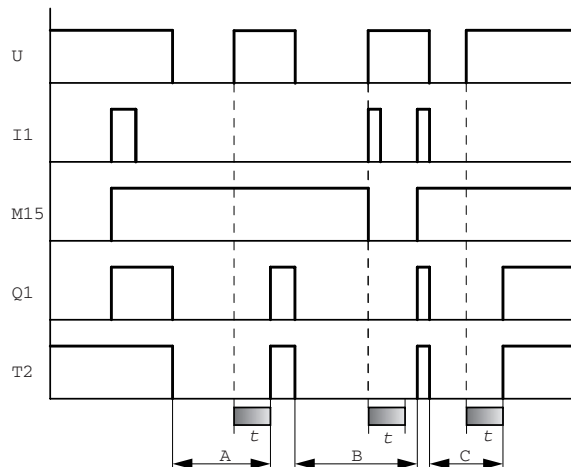

U = Supply voltage

Range A: Q1 was on prior to losing power. When power is re-applied and the T2 timer expires, Q1 turns back on.

Range B: Q1 was on prior to losing power. When power is re-applied, switch I1 is on, so Q1 stays off. Use time T2 to avoid brief flicker.

Range C: M15 is switched on and remains set until the next time I1 is activated.

S/R Function

Task:

After a power failure, the lights in a stairwell should resume their previous switching state. (This is another method to solve the same task.)

Contacts and relays used:

Coil	Function
T2	Enable after first cycle
I1	Push-button
M1	Push-button pulse (rising edge detection)
M2	Pulse limitation (one shot)
Q1	Lamp output
M15	Impulse relay (retentive)

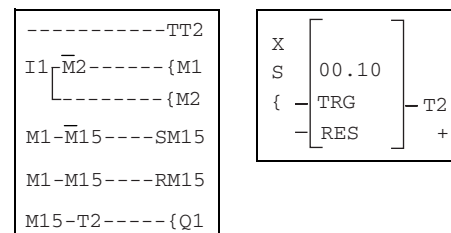

Signal diagram:

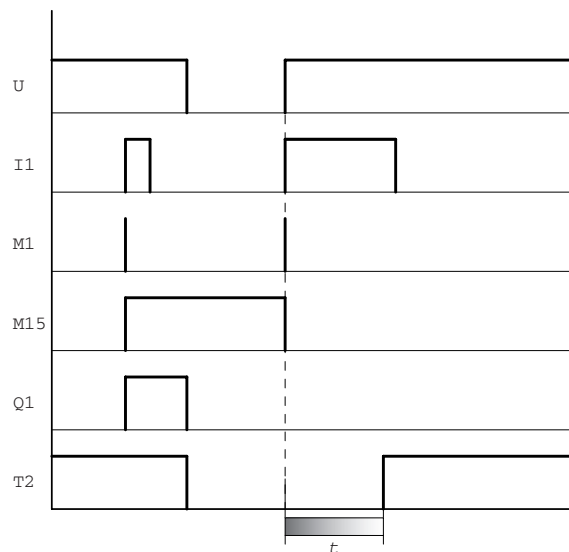

U = Supply voltage

The circuit above functions in the same way as an impulse relay switch. The make contact remains switched on in the first Pico cycle if:

- a coil is actuated by the make contact of a retentive marker (series and parallel connection both apply here too), and
- when the power is switched on, the reset condition for this retentive marker is on.

The enable time, T2, prevents Q1 from flickering.

Retentive Timing Relays

Use of Retention

The retentive timing relays T7 and T8 can be operated retentively in all six different switching functions. The retention setting only works under certain conditions for the switching functions. These can be subdivided into groups 1 and 2.

If these conditions are not fulfilled, the actual value is cleared when the power is restored. If the R coil (Reset) is actuated, the actual value is also cleared.

Group	Retentive Function
Group 1	On-delayed On-delayed switching with random range Single-pulse Flashing
Group 2	Off-delayed Off-delayed switching with random time range

Retention with Group 1

Requirement:

When power is applied to Pico, actuated trigger coils TT7, TT8 can retain their state '1' (switched on) until the preset time period has elapsed. This can be implemented using retentive markers or inputs connected to power.

Retention with Group 2

Requirement:

When power is applied to Pico, actuated trigger coils TT7 and TT8 can retain their state '0' (switched off) until the preset time period has elapsed. This can be implemented using retentive markers or inputs connected to power.

Examples

On-Delayed, Switching On-Delayed with Random Range, Retentive

Task 1 (On-Delayed):
 A motor must start up 30 seconds after an enable signal is given.

This task is implemented using an input device which retains its '1' state on power-up.

Contacts and relays used:

Coil	Function
I1	Motor Enable
Q2	Motor
T8	Delay time

Circuit Diagram:

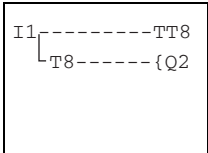

Parameter Display:

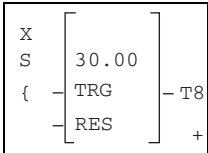

Signal diagram:

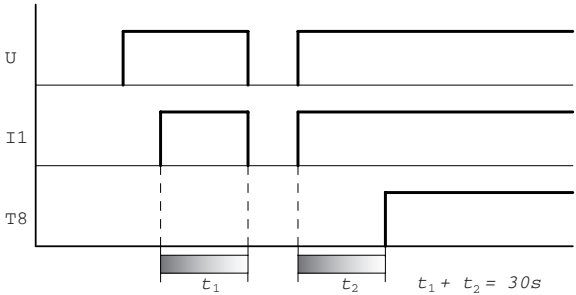

U = Supply voltage

I1 must be activated when the power is turned back on.

Task 2

A conveyor belt is to be run empty. This no-load running is implemented by using a time relay to keep the belt running following the STOP BELT command until the preset time has elapsed. If this procedure is interrupted by an interruption of power, the belt is only permitted to run empty after power-up for the remainder of the preset time period. This task is implemented using retentive markers.

Contacts and relays used:

Coil	Function
T6/T7	One shot timers
I2	Start conveyor belt
Q1	Conveyor belt motor
I3	Stop conveyor belt
M16	Stop selected
T8	Remaining time

Circuit Diagram:

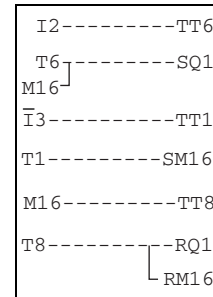

Parameters Entered:



Time setting for T6, T7 []

I2 and I3 are converted to one-shot pulses by T6 / T7. Only the actuation of the push-button is recognized. Should they remain constantly pressed, malfunctions would occur. In the above example, T7 does not have to be retentive.

I2 is a normally open push button, and I3 is a normally closed push button. A normally closed push button is used for the STOP CONVEYOR signal so that in the event of a loose or broken wire, the conveyor automatically stops.

Signal diagram:

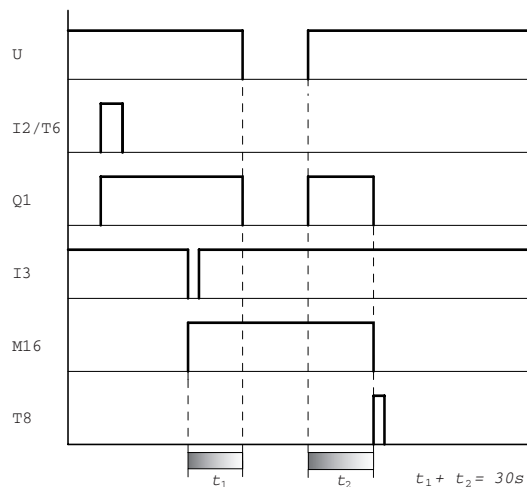

U = Supply voltage

The make contact of T8 closes for one Pico cycle and resets M16, Q1.

Off-Delayed, Off-Delayed Switching with Random Time Range, Retentive

Task:

No-load running of a conveyor belt. (Same as the previous example except implemented using an off-delay timer)

Contacts and relays used:

Coil	Function
T6/T7	Single pulse
I2	Start conveyor belt
Q1	Conveyor belt motor
I3	Stop conveyor belt
M16	Stop selected
T8	Remaining time

Circuit Diagram:

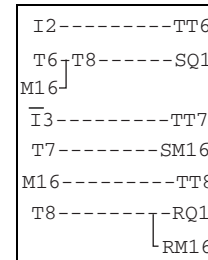

Parameters Entered:

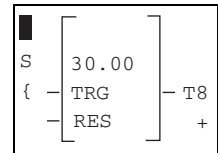

Time setting for T6, T7 \square

I2 and I3 are converted to one-shot pulses by T6/T7. Only the actuation of the push-button is recognized. In the above example, T7 does not have to be retentive.

Signal diagram:

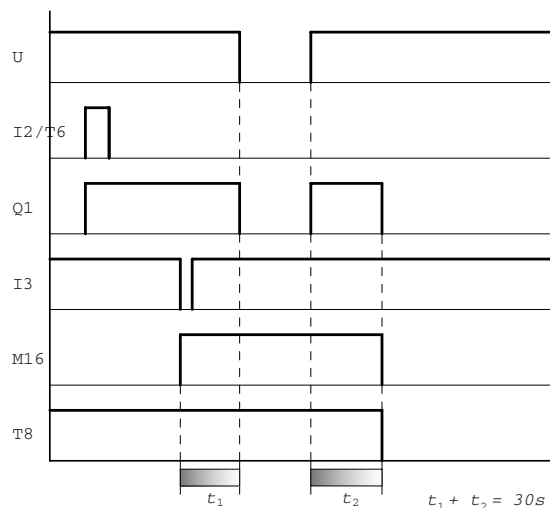

U = Supply voltage

Single-Pulse Timing Relays, Retentive

Single-pulse timing relays are suitable for metering adhesives, liquids etc.

Task: A lubricating device is to always dispense the same quantity of oil.

Contacts and relays used:

Coil	Function
I1	Start lubrication
Q1	Oil valve
T8	Oil time

Circuit Diagram:

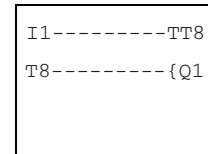

Parameters entered:

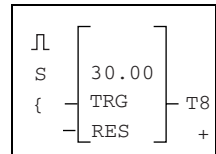

Signal diagram:

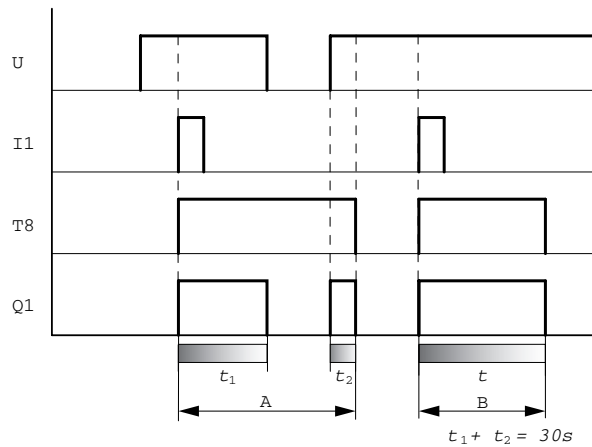

U = Supply voltage

Range A: In this case, the power is interrupted. When power is restored, the output stays on for the remaining time.

Range B: The time period expires without interruption.

Flashing Switch Operation, Retentive

Task:

A flasher function is used to lower an ink stamp at identical time intervals to print an area and then to raise the stamp to prepare for the next hit.

Contacts and relays used:

Coil	Function
Q1	Valve
T8	Time

Circuit Diagram:

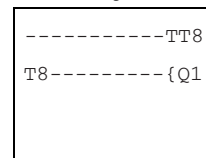

Parameters entered:

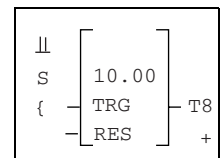

Signal diagram:

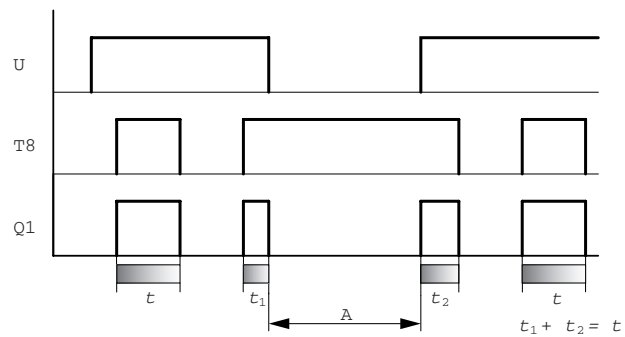

U = Supply voltage

Range A:

Within this range, the power is turned off. Following another power-on, the remaining time runs until finished.

Retentive Up/Down Counters C7 and C8

How the Retention Works

The actual values of counters C7 and C8 are retentive. When the condition for resetting the counter is satisfied, the actual value of the counter will be reset.

Examples

Counting Parts

Task 1

Parts are packed automatically in a shipping carton. Even if there is a power outage, the correct number should still be packed into the carton. When the carton is full, the carton is removed manually and the counter is reset.

Contacts and relays used:

Coil	Function
I5	Count parts
I6	Reset counter
Q1	Carton Full, signal lamp
C8	Up counter

Circuit Diagram:

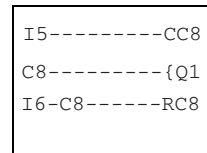

Parameters entered:

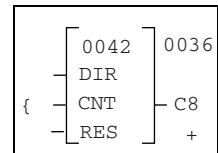

Signal diagram:

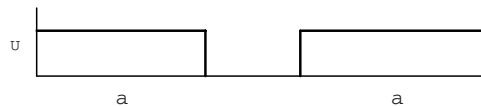

U = Supply voltage

Operating Hours Counter for Maintenance Intervals

Task 2

Every 1000 hours, the system or machine must undergo preventive maintenance. Filters and transmission oil must be changed and the bearings must be lubricated.

Contacts and relays used:

Coil	Function
T8	Clock pulse
M16	Block double pulse
Q4	Warning light, 1000 h reached
C8	Up counter
I1	Reset

Circuit Diagram:

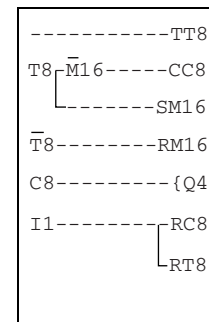

Parameters entered:

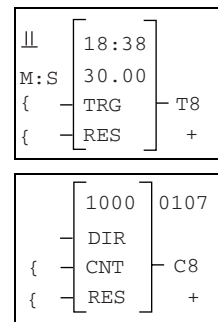

Function of the Pico circuit diagram:

T8 provides the clock pulse. When a time of $t = 30$ minutes is selected, the counting period amounts to $2 \times t = 60$ min. Every hour, one pulse is counted. The up counter C8 triggers a warning light at 1000 by means of Q4.

For the clock pulse to be correct when there is a power outage, T8 must be retentive.

M16 prevents C8 from accidentally receiving a counter pulse when the power is turned back on if there was a power outage during the counting period.

Both M16 and C8 must retain their actual values at power outage so that the 1000 hours of operating with interruptions in the power supply can be counted.

I1 (for example, a key-operated switch) is used to reset the counter.

Signal diagram:

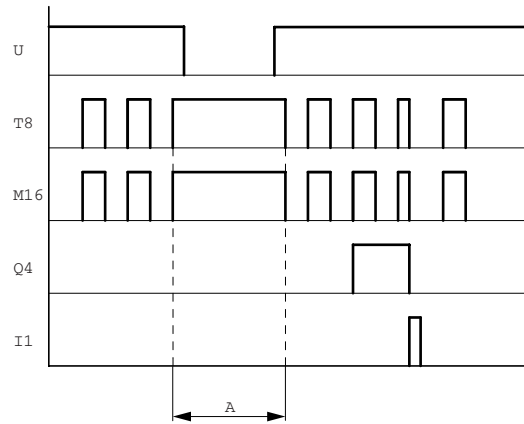

U = Supply voltage

Range A:

Value before power outage: 107

Value after switching back on: 107

Automatic Lubrication at Constant Intervals and With a Constant Quantity of Lubricant

Task 3:

After every 60 minutes of machine run time, the bearings of the machine must be lubricated for 30 seconds.

Contacts and relays used:

Coil	Function
T1	Clock pulse
M15	Lubricate
Q1	Lubrication Valve
T8	Lubrication time
C8	Up counter

Function of the Pico circuit diagram:

T1 provides the clock pulse. When a time of $t = 0.5$ seconds is selected the counting period amounts to $2 \times t = 1$ s. One pulse is counted every second. The up counter C8 switches valve Q1 on via M15 at 3600 counting pulses ($3600 \text{ s} = 1 \text{ h}$).

M15 resets C8 and prepares C8 for the next hour. To stop C8 from continuing to count while lubrication is in process, the break contact of M15 blocks the counting of pulses.

T8 is actuated by means of M15. Once T8 has timed out, M15 and T8 will be reset.

In order that both the time elapsed since the last lubrication (counter C8) and also the lubrication pulse remains constant in the event of a power outage, C8, M15 and T8 must be retentive.

Circuit Diagram:

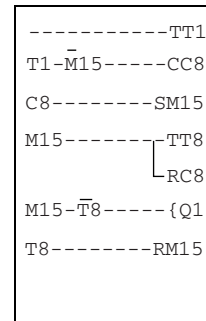

Parameters entered:

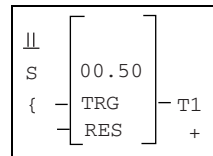

Parameter Display:

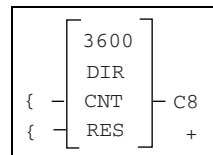

Parameters entered:

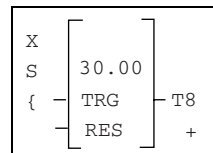

Signal diagram:

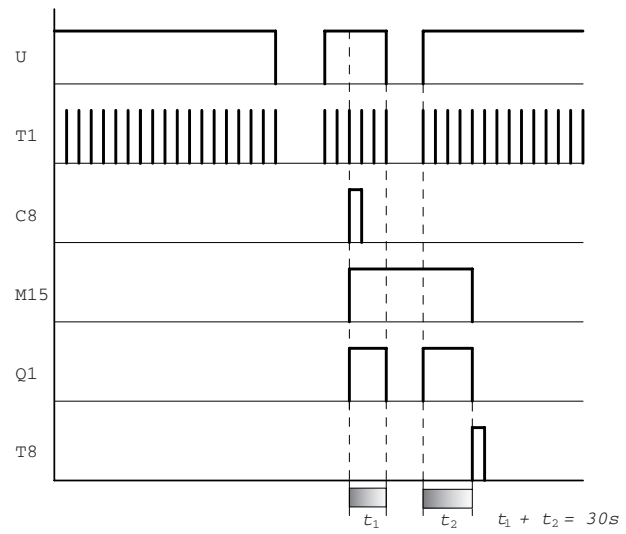

U = Supply voltage

Inside Pico

Circuit Diagram Cycle

In conventional control systems, relay control processes all the circuit connections in parallel. The speed with which a relay switches is thus dependent on the components used, and ranges from 15 to 40 ms for relay pick-up and drop-out.

With Pico, the circuit diagram is processed with a microprocessor that simulates the contacts and coils of the relay logic and thus processes all switching operations considerably faster. Depending on its size, the Pico circuit diagram is processed cyclically every 2 to 40 ms.

During this time, Pico passes through five segments in succession.

How Pico Evaluates the Circuit Diagram

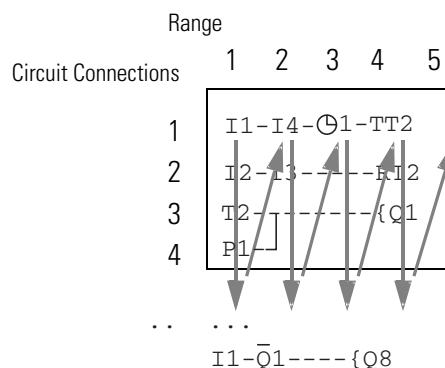

In the first three segments, Pico evaluates the contact fields in succession. As it does so, Pico also checks whether contacts are connected in parallel or in series and stores the switching states of all the contact fields.

In the fourth segment, Pico assigns the new switching states to all the coils in one pass.

The fifth segment is outside the circuit diagram. Pico uses this to make contact with the 'outside world': Output relays Q1 to Q... are switched and inputs I1 to I... are read. Pico also copies all the new switching states to the status image register.

Pico only uses this status image for one cycle. This ensures that each circuit connection is evaluated with the same switching state for one cycle, even if the input signals I1 to I12 change their status several times within a cycle.

Evaluation in the Circuit Diagram and High-Speed Counter Functions

When using high-speed counter functions, the signal state is continuously counted or measured regardless of the processing of the circuit diagram. (C13, C14 high-speed up/down counters, C15, C16 frequency counters.)

How Does This Affect Creation of the Circuit Diagram?

Pico evaluates the circuit diagram in these five segments in order. You should therefore remember two points when you create your circuit diagrams:

- The changeover of a relay coil does not change the switching state of an associated contact until the next cycle starts.
- Always wire forward or from top to bottom. Never work backward.

Example: Switch One Cycle Later

This is the circuit diagram of a self-latching circuit. If I1 and I2 are closed, the switching state of relay coil {Q1 is “held” via contact Q1.

Circuit Diagram:

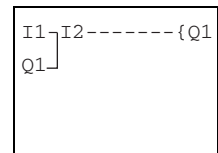

1st cycle: I1 and I2 are switched on. Relay {Q1 picks up.

Start Condition:
I1, I2 switched on
Q1 switched off

Relay contact Q1 remains off since Pico evaluates from left to right.

2nd cycle: The self-latching function now becomes active. Pico has transferred the coil states to contact Q1 at the end of the first cycle.

Example: Do Not Wire Backward

This example is shown in Create and Modify Connections on page 4-10. It was used to illustrate how NOT to program.

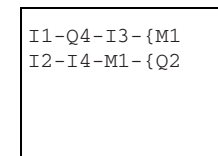
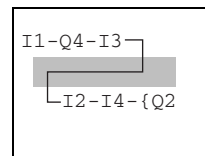

When wiring more than three contacts in series, use one of the marker relays.

Determine Cycle Time of Circuit Diagrams

The maximum cycle time of a circuit diagram must be known in order to determine the maximum counter frequency or reaction time of Pico.

Blank Cycle Time Calculation Tables can be found on page A-13 of this manual.

1760-L12xxx Cycle Time

For 1760-L12xxx, the cycle time can be calculated as follows:

Function	Number	Time Duration in μs	Total
Basic pulse	1	210	–
Refresh	1	3500	–
Contacts and bridged contact fields	–	20	–
Coils	–	20	–
Total rungs from the first one to the last one, with empty ones in between	–	50	–
Connecting lines (only Γ , L , \vdash)	–	20	–
Timing relays	–	–	–
Counters	–	–	–
Analog value function relays	–	–	–
Total			–

List of Times for Processing Function Relays

Number	1	2	3	4	5	6	7	8
Timing relays in μs	20	40	80	120	160	200	240	280
Counters in μs	20	50	90	130	170	210	260	310
Analog value processors in μs	80	100	120	140	160	180	220	260

Example: Parallel Circuit

Calculate the maximum cycle time for the following circuit diagram:

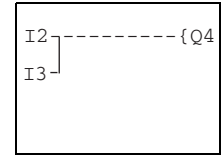

Function	Number	Time Duration in μ s	Total
Basic pulse	1	210	210
Refresh	1	3500	3500
Contacts and bridged contact fields	4	20	80
Coils	1	20	20
Total rungs from the first one to the last one, with empty ones in between	2	50	100
Connecting lines (only Γ , \perp , \vdash)	–	20	–
Timing relays	–	–	–
Counters	–	–	–
Analog value function relays	–	–	–
Total			3910

Example: Circuit with Branches

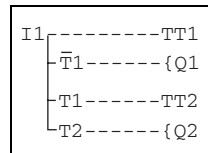

Function	Number	Time Duration in μ s	Total
Basic pulse	1	210	210
Refresh	1	3500	3500
Contacts and bridged contact fields	9	20	180
Coils	4	20	80
Total rungs from the first one to the last one, with empty ones in between	4	50	200
Connecting lines (only Γ , \perp , \vdash)	3	20	60
Timing relays	2	40	40

Function	Number	Time Duration in μ s	Total
Counters	–	–	–
Analog value function relays	–	–	–
Total			4270

Example: Operating Hours Counter

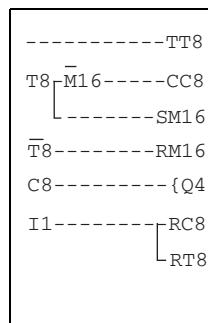

Function	Number	Time Duration in μ s	Total
Basic pulse	1	210	210
Refresh	1	3500	3500
Contacts and bridged contact fields	17	20	340
Coils	7	20	140
Total rungs from the first one to the last one, with empty ones in between	7	50	350
Connecting lines (only \lrcorner , \llcorner , \lrcorner)	2	20	40
Timing relays	1	20	20
Counters	1	20	20
Analog value function relays	–	–	–
Total			4620

1760-L18xxx Cycle Time

For 1760-L18xxx, the cycle time can be calculated as follows:

Function	Number	Time Duration in μ s	Total
Basic pulse	1	520	–
Refresh	–	5700	–
Contacts and bridged contact fields	–	40	–
Coils	–	20	–
Total rungs from the first one to the last one, with empty ones in between	–	70	–
Connecting lines (only Γ , \perp , \vdash)	–	40	–
Timing relays	–	–	–
Counters	–	–	–
Analog value function relays	–	–	–
Total			–

List of Times for Processing Function Relays

Number	1	2	3	4	5	6	7	8
Timing relays in μ s	40	120	160	220	300	370	440	540
Counters in μ s	40	100	160	230	300	380	460	560
Analog value processors in μ s	120	180	220	260	300	360	420	500

Example: Operating Hours Counter

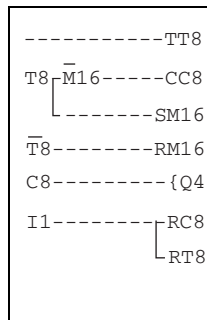

Function	Number	Time Duration in μ s	Total
Basic pulse	1	520	520
Refresh	–	5700	5700
Contacts and bridged contact fields	17	40	680
Coils	7	20	140
Total rungs from the first one to the last one, with empty ones in between	7	70	490
Connecting lines (only Γ , \perp , \vdash)	2	40	180
Timing relays	1	–	60
Counters	1	–	40
Analog value function relays	–	–	–
Total			7710

Delay Times for Inputs and Outputs

The time from an input physically energizing to the time Pico actually reads the input is called the input delay time, and can be set in Pico.

This function is useful, for example, to ensure a clean input signal despite contact bounce.

Pico DC and Pico AC units function with different input voltages and therefore have different evaluation methods and delay times.

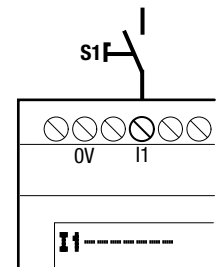

Delay Times for Pico DC Units (1760-L12BWB-xx, 1760-L12DWD and 1760-L18BWB-EX)

The debounce delay time for DC signals is 20 ms.

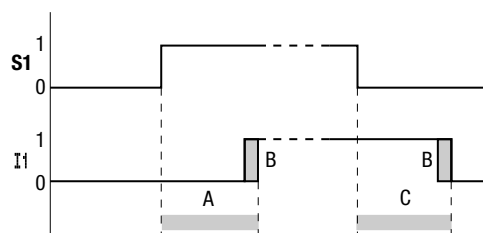

An input signal, S1, must be present at the input terminal for at least 20 ms before the switch contact will change from 0 to 1 (A) in the program. If applicable, this time must also include the program cycle time (B) since Pico does not detect the signal until the start of a cycle.

The same debounce delay (C) applies when the signal drops out from 1 to 0.

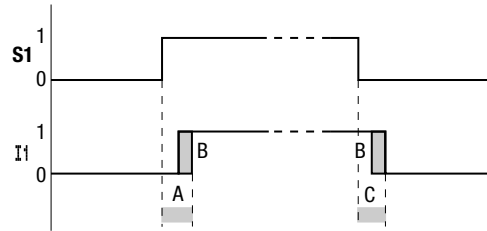

Typical delay times with the input debounce delay turned off are a few hundred μs , and are given in the specifications in Appendix A.

IMPORTANT

Check that there is no electrical interference affecting the input signals when the input delay is disabled. Pico responds even to very short signals.

Delay Times for Pico AC Units (1760-L12AWA-xx and 1760-L18AWA-xx)

The input delay with AC voltage signals depends on the frequency:

- On-delay:
 - 66 ms at 60 Hz, 80 ms at 50 Hz
- Off-delay:
 - I1 to I6 and I9 to I12: 66 ms at 60 Hz, 80 ms at 50 Hz
 - I7 and I8: 150 ms at 60 Hz, 160 ms at 50 Hz (1760-L12AWA-xx)
 - I7 and I8: 66 ms at 60 Hz, 80 ms at 50 Hz (1760-L18AWA-xx)

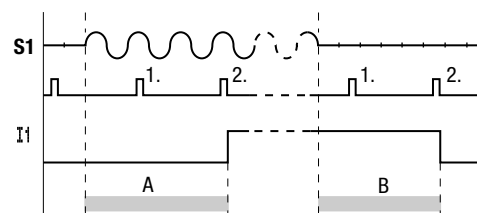

If the delay is switched on, Pico checks at 33 ms (40 ms for 50 Hz) intervals whether there is a half-wave present at an input terminal (1st and 2nd pulses in A). If Pico detects two pulses in succession, the device switches on the corresponding input internally.

If this is not the case, the input is switched off again as soon as Pico does not detect two successive half-waves (1st and 2nd pulses in B).

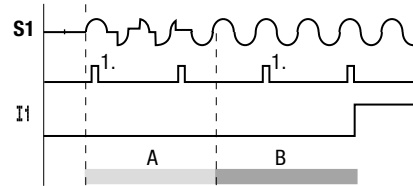

If a button or switch bounces (A), the delay time may be extended by 33 ms at 60 Hz (40 ms at 50 Hz) (A).

If the input delay is switched off, the delay time is reduced.

- On-delay
 - 16.6 ms at 60 Hz, 20 ms at 50 Hz
- Off-delay:
 - I1 to I6 and I9 to I12: 16.6 ms at 60 Hz, 20 ms at 50 Hz
 - I7 and I8: 100 ms at 60 Hz and 50 Hz (1760-L12AWA-xx)
 - I7 and I8: 16.6 ms at 60 Hz, 20 ms at 50 Hz (1760-L18AWA-xx)

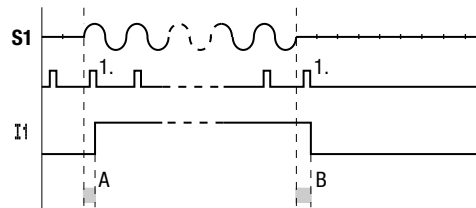

Pico switches the contact as soon as it detects a pulse (A). If no pulse is detected, Pico switches off the contact (B). The procedure for changing the delay times is described in Activate Debounce (Input Delay) on page 6-10.

Use of Expansion Modules

Overview

Additional I/O points can be added to the 1760-Lxxxxx-EX Pico models.

To do this, first install the expansion module and connect the inputs and outputs. See the following sections of this manual:

For	See
Mounting	Connect the Expansion Module on page 2-3
Power Supply Connections	1760-IA12XOW6I Expansion Module on page 2-10 1760-IB12XOB8 Expansion Module on page 2-11
Input Wiring	Example Using 1760-IA12XOW6I on page 2-15 Example Using 1760-IB12XOB8 on page 2-18 Expansion Modules on page 1-4
Output Wiring	1760-L12AWA-xx, 1760-L12BWB-xx and 1760-L12DWD on page 2-22 1760-L18AWA-xx and 1760-L18BWB-EX on page 2-23 1760-IA12XOW6I on page 2-23 1760-OW2 on page 2-23

Inputs

Use the inputs of the expansion modules as contacts in the Pico circuit diagram as you would use the inputs on the Pico controller. The expansion inputs are R1 to R12.

TIP

R15 and R16 are used for expansion overload detection for the transistor expansion module, 1760-IB12XOB8, as described on page 9-4.

Outputs

Expansion module outputs are processed as relay coils or contacts in the same way as they are on the Pico controller. The expansion output relays are numbered S1 to S8.

Expansion module 1760-IA12XOW6I provides 6 relay outputs. The other outputs, S7 and S8, can be used as markers.

Expansion module 1760-IB12XOB8 provides 8 transistor outputs. See Monitor for Short Circuit or Overload on page 9-4 for information on output faults.

Operation

How the Expansion Module is Recognized

When at least one R contact or S contact/coil is used in the circuit diagram, the Pico controller assumes that an expansion module is connected.

Data Transfer Behavior

The input and output data of the expansion module is transferred serially in both directions. Take into account the modified reaction times of the inputs and outputs when using expansion modules.

Input and Output Reaction Times of Expansion Modules

TIP

The debounce setting has no effect on expansion modules.

Transfer Times for Input and Output Signals

Input or Output	Reaction Time
R1 to R12	30 ms + one cycle
S1 to S6 (or S8)	15 ms + one cycle time

Monitor Functions of the Expansion Module

Be Sure Power Supply is Present

If the power supply of the expansion module is not present, no connection can be established between it and the Pico controller. When no power supply is present, the expansion inputs, R1 to R12 and R15 and R16, are incorrectly processed in the Pico controller and show status of 0. Also, it cannot be assured that outputs S1 to S8 will be transferred to the expansion module.

ATTENTION



Always monitor the expansion module to prevent switching faults in machines or systems.

Expansion Module Status

The status of the Pico controller internal input I14 indicates the status of the expansion module, as follows:

Expansion Module Status

Pico Controller Input	Status
I14 = 0	Expansion module is functional.
I14 = 1	Expansion module is not functional.

Monitor for Short Circuit or Overload

Expansion module 1760-IB12XOB8 provides 8 transistor outputs. The outputs are thermally protected, and switch off in the event of an overload or short circuit. After a cooling period, a faulted output re-energizes in an attempt to operate the output load. If the fault condition still exists, the output will overheat and switch off again. This process is repeated until the overload is removed (or until power is turned off).

You can use internal inputs R15 and R16 to monitor for short circuits or overloads on an output. Each of the bits (R15 and R16) monitors a group of four outputs.

- R15: Group fault signal for outputs S5 to S8
- R16: Group fault signal for outputs S1 to S4

The bit is active (1) when one or more of the outputs in the group has been faulted. An overload fault is indicated as follows.

If the Status is:		Then:
R15	R16	
0	0	No overload.
0	1	At least one output has a fault in Group S1 to S4.
1	0	At least one output has a fault in Group S5 to S8.
1	1	At least one output has a fault in each Group.

IMPORTANT

Monitor these bits (R15 and R16) in your logic program to be sure that system or machine operations are handled in an orderly manner in the event of an output fault.

Module Status Example

Power can be applied to the expansion unit later than it is applied to the Pico controller. This means that Pico is switched to Run with the expansion module missing. The Pico circuit diagram below detects whether the expansion unit is operational or not.

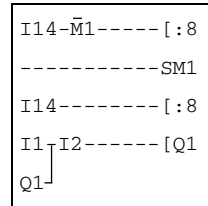

As long as $I14 = 1$, the remaining circuit diagram is skipped. If $I14 = 0$, the circuit diagram is processed. If the expansion module drops out for any reason, the circuit diagram is skipped. $M1$ detects whether the circuit diagram was processed for at least one cycle after the power supply switched on. If the circuit diagram is skipped, all the outputs retain their previous state. The next example should be used if this is not desired.

Example with LCD Output and Reset of the Outputs

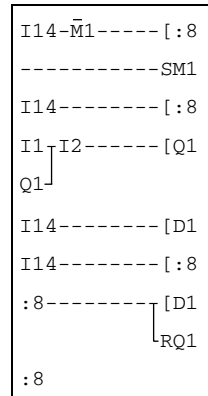

Troubleshoot Your Controller

You may sometimes find that Pico does not do exactly what you expect. If this happens, read through the following notes which are intended to help you solve some of the problems you may encounter.

Use the power flow display in Pico to check the logic operations in the Pico circuit diagrams with reference to the switching states of contacts and relays.

Only qualified persons should test Pico voltages while the device is in operation.

Messages from the Pico System

Pico System Messages on the LCD	Explanation	Remedy
No display	Power interrupted	Turn on the power.
	Pico LCD faulty	Replace the Pico.
Continuous display		
TEST: AC	Self-test aborted	Replace the Pico.
TEST: EEPROM		
TEST: DISPLAY		
TEST: CLOCK		
ERROR: I2C	Memory module removed or not inserted correctly before saving	Insert the memory module.
	Memory module faulty	Replace the memory module.
	Pico is faulty	Replace the Pico.
ERROR: EEPROM	The memory for storing the retentive values or the Pico circuit diagram memory is faulty.	Replace the Pico.
ERROR: CLOCK	Clock error	Replace the Pico.
ERROR: LCD	LCD is faulty	Replace the Pico.
ERROR: ACLOW	Incorrect ac voltage	Test the voltage.
	Pico is faulty	Replace the Pico.

Possible Situations When Creating Circuit Diagrams

Possible Situations When Creating Circuit Diagrams	Explanation	Remedy
Cannot enter contact or relay in circuit diagram	Pico is in Run mode	Select Stop mode.
Time switch switches at wrong times	Incorrect time or time switch parameters	Check time and parameters.
Cannot select analog comparator 'Ax'	Pico ac versions have no analog inputs	Use Pico dc for comparing analog values.
Cannot select time switch contacts	Pico has no clock	'-NC' version does not have a clock.
When using a memory module Pico will display the message 'PROG INVALID'	Pico memory module contains no circuit diagram	Change the version of Pico or change the circuit diagram in the memory module.
	Circuit diagram on the memory module uses contacts /relays that Pico does not recognize: <ul style="list-style-type: none"> • Do not use "-NC" versions for time switch functions • Analog inputs only with DC controllers 	
Current flow display does not show modifications to the circuit connections	Pico is in Stop mode	Select Run mode.
	Operation / connection not performed	Check the circuit diagram and parameter sets and modify as required.
	Relay does not activate coil	
	Incorrect parameter values / time <ul style="list-style-type: none"> • Analog value comparison is incorrect • Time value of timing relay is incorrect • Function of timing relay is incorrect 	
Relay 'Q' or 'M' does not pick up	Relay coil has been wired up several times	Check coil field entries.
Input not detected	Loose terminal contact	Check installation instructions, and external wiring.
	No voltage to switch/button	
	Broken wire	
	Pico input is faulty	Replace the Pico.

Possible Situations When Creating Circuit Diagrams	Explanation	Remedy
Relay output 'Q' does not switch and activate the load	Pico in Stop mode	Select Run mode
	No voltage at relay contact	Check installation instructions, and external wiring.
	Pico power supply interrupted	
	Pico circuit diagram does not activate relay output	
	Broken wire	
	Pico relay is faulty	Replace the Pico

Event

Event	Explanation	Remedy
The actual values are not being stored retentively.	Retention has not been enabled.	Enable retention in the SYSTEM menu.
The RETENTION... menu is not displayed in the SYSTEM menu.	Pico is in Run mode	Select Stop mode.
The SYSTEM menu is not displayed.	Pico is password protected	Unlock Pico's password.
Pico starts only in Stop mode	No circuit diagram in Pico	Load an input circuit diagram.
	Start-up behavior is set to the function "Start-up in operating mode STOP".	Set the start-up behavior in the SYSTEM menu.
LCD display showing nothing	No power supply	Switch on the power supply.
	Pico is faulty	Press the Ok button. If no menu appears, replace the Pico.
	Text displayed with too many spaces	Enter text.

DC Simulator

Description

The DC Simulator, catalog number 1760-SIM, can be used to simulate Pico inputs and outputs to test and troubleshoot programs. The simulator contains three components: input simulator board, output simulator board, and wall-mount power supply. The illustration on page 11-2 shows how to connect the simulator to Pico.

The input simulator board contains 8 maintained push buttons connected to the 8 inputs of Pico as well as 2 potentiometers connected to Inputs 7 and 8. The push buttons simulate digital input devices such as limit switches, proximity sensors, and photoswitches. The potentiometers can be used to simulate analog input devices such as temperature and pressure transducers. The output board contains four LEDs that simulate output devices such as relays, motor starters, or solenoids.

ATTENTION

The DC simulator can only be used with:

- 1760-L12BWB
- 1760-L12BWB-NC
- 1760-L12BWB-ND
- 1760-L12BBB
- 1760-L12BBB-ND

Use only the power supply provided.

Installation Guidelines

ATTENTION



Be sure that power is not applied when installing the input and output simulator boards. Follow the installation procedure below.

Installation Procedure

1. Connect inputs.
2. Connect outputs.
3. Plug in the connection cable.
4. Connect the power supply.
5. Plug in the power supply unit.

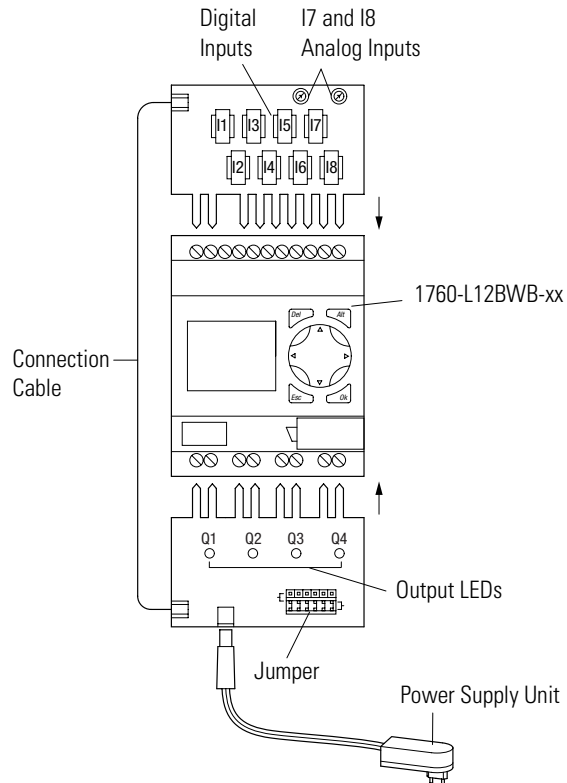

IMPORTANT

Observe the following precautions when using the DC Simulator:

1. The jumper on the circuit board must be in the RC (lower) position. The simulator will not operate if the jumper is in the TC (upper) position.
2. When using the digital input switches for inputs I7 and/or I8, make certain that the corresponding analog input potentiometers are fully rotated to the OFF (clockwise) position.
3. When using the analog input potentiometers for inputs I7 and/or I8, be certain that the corresponding digital input switches are in the OFF position.

Specifications

Physical Specifications

Specification	1760-L12xxx	1760-L18xxx, 1760-L20xx 1760-IA12XOW6I, 1760-IA12XOW4I 1760-IB12XOB8 1760-IB12XOB8	1760-OW2
Dimensions W x H x D	71.5 mm (2.82 in.) x 90 mm (3.55 in.) x 56.5 mm (2.08 in.)	107.5 mm (4.24 in.) x 90 mm (3.55 in.) x 56.5 mm (2.08 in.)	35.5 mm (1.4 in) x 90 mm (3.55 in.) x 56.5 mm (2.08 in.)
Weight [g]	200g (7 oz.)	300g (10.6 oz)	70
Mounting	DIN Rail 50022, 35 mm or screw mounting with 3 or 4 mounting feet		
Solid/Stranded	AWG 22 to AWG 12		
Slot-head screwdriver, width	3.5 x 0.8 mm		
Tightening torque	0.57 to 0.79 Nm (5 to 7 lb-in)		

Environmental Specifications

These environmental specifications apply to all of the Bulletin 1760 products.

Ambient climatic conditions		
Specification	Value	Standard
Operating Temperature	-25°C to +55°C (-13°F to +131°F)	—
Storage/transport temperature	-40°C to +70°C (-40°F to +158°F)	—
Operating humidity	5 to 95%, non-condensing	IEC 60068-2-30
Air pressure (operation)	795 to 1080 hPa (0.795 to 1.08 Bar)	—
Corrosion resistance	SO ₂ 10 cm ³ /m ³ , 4 days	IEC 60068-2-42
	H ₂ S 1 cm ³ /m ³ , 4 days	IEC 60068-2-43

Electrical Specifications

Ambient mechanical conditions		
Specification	Value	Standard
Pollution degree	2	–
Protection class	IP 20	EN 50178, IEC 60529, VBG4
Vibration	10 to 57 Hz (constant amplitude 0.15 mm)	IEC 60068-2-6
	57 to 150 Hz (constant acceleration 2G)	
Shock	18 shocks (semi-sinusoidal 15G/11 ms)	IEC 60068-2-27
Drop	50 mm (1.97 in)	IEC 60068-2-31
Drop, packaged	1m (39.4 in)	IEC 60068-2-32
Electromagnetic compatibility (EMC)		
Electrostatic discharge	8 KV air discharge, 6 KV contact discharge	IEC/EN 61000-4-2, severity level 3
Electromagnetic fields	Field strength 10 V/m	IEC/EN 61000-4-3
Emitted interference, interference immunity	Class B	EN 55011, EN 55022
Fast Transient Burst	2 KV power supply 2 KV signal cables	IEC/EN 61000-4-4, severity level 3
High-energy pulses (surge) Pico 1760-LxxAWA 1760-IA12XOW6I	2 KV power cable symmetrical	IEC/EN 61000-4-5
High-energy pulses (surge) Pico 1760-LxxBWB-xx 1760-IB12X0B8	0.5 KV power cable symmetrical	IEC/EN 61000-4-5, severity level 2
Line Conducted Interference	10V	IEC/EN 61000-4-6
Dielectric strength		
Clearance and creepage distances	EN 50178, UL 508, CSA C22.2, No 142	
Dielectric strength	EN 50178	
Backup/accuracy of real-time clock (except '-NC')		
Clock capacitor back-up		
at 25°C (77°F)	Nominal 64 hours	
at 40°C (104°F)	Nominal 24 hours	
Accuracy of the real-time clock	Nominal ±5s/day, ± 0.5 h/year	
Repetition accuracy of timing relays		
Accuracy of timing relays	±1% of value	

Ambient mechanical conditions		
Specification	Value	Standard
Resolution		
Range "s"	10 ms	
Range "M:S"	1 s	
Range "H:M"	1 min.	
Retentive memory		
Write cycles of the retentive memory	≥100,000	

Power Supply

AC Models

Incoming Power	1760-L12AWA 1760-L12AWA-NC 1760-L12AWA-ND	1760-L18AWA 1760-L18AWA-EX 1760-L18AWA-EXND 1760-IA12XOW6I	1760-L12NWN 1760-L12NWN-ND 1760-L18NWN-EX 1760-L18NWN-EXND
Rated value (sinusoidal)	100 to 240V ac +10/-15%	100 to 240V ac +10/-15%	24V ac, +10/-15 %
Range	90 to 264V ac	85 to 264V ac	20.4 to 26.4V ac
Frequency, rated value, tolerance	50/60 Hz, ±5%	50/60 Hz, ±5%	50/60 Hz, ±5%
Line Current			
at 115/120V ac 60 Hz	Nominal 40 mA	Nominal 70 mA	
at 230/240V ac 50 Hz	Nominal 20 mA	Nominal 35 mA	
at 24V ac 50/60 Hz			Nominal 200 mA (1760-L12) Nominal 300 mA ((1760-L18)
Voltage dips	20 ms, EN 61131-2	20 ms, EN 61131-2	20 ms, EN 61131-2
Power Consumption			
at 115/120V ac	Nominal 5 VA	Nominal 10 VA	
at 230/240V ac	Nominal 5 VA	Nominal 10 VA	
at 24V ac			Nominal 5 VA (1760-L12) Nominal 7 VA (1760-L18)

DC Models

Incoming Power	1760-L12DWD 1760-L12DWD-ND	1760-L18DWD-EX 1760-L18DWD-EXND	1760-L12BBB 1760-L12BBB-ND 1760-L12BWB 1760-L12BWB-NC 1760-L12BWB-ND	1760-L18BWB-EX 1760-L20BBB-EX 1760-L20BBB-EXND 1760-IB12X0W6I 1760-IB12X0B8
Rated voltage				
Rated value	12V dc, +30%, -15%	12V dc, +30%, -15%	24V dc, +20%, -15%	24V dc, +20%, -15%
Range	10.2 to 15.6V dc	10.2 to 15.6V dc	20.4 to 28.8V dc	20.4 to 28.8V dc
Residual ripple	≤5%	≤5%	≤5%	≤5%
Input current	Nominal 140 mA at 12V dc	Nominal 200 mA at 12V dc	Nominal 80 mA at 24V dc	Nominal 140 mA at 24V dc
Voltage dips	10 ms, EN 61131-2	10 ms, EN 61131-2	10 ms, EN 61131-2	10 ms, EN 61131-2
Power dissipation at 24V dc	Nominal 2 W	Nominal 3.5 W	Nominal 2 W	Nominal 3.5 W

Inputs**AC Models**

Specification	1760-L12NWN 1760-L12NWN-ND	1760-L18NWN-EX 1760-L18NWN-EXND
Digital inputs 24V ac		
Number	8	12
Status display	LCD (if provided)	LCD (if provided)
Electrical isolation		
To power supply	No	No
Between Inputs	No	No
to the outputs	Yes	Yes
Rated voltage (sinusoidal)		
off state	0 to 6V ac	0 to 6V ac
on state	14 to 26.4V ac	14 to 26.4V ac
Rated frequency	50/60 Hz	50/60 Hz
Input current I1 to I6 (1760-L18NWN-xx also I9 to I10)	4 mA at 24V ac 50 Hz	4 mA at 24V ac 50 Hz
Input current I7, I8 (1760-L18NWN-xx also I11 and I12)	2 mA at 24V ac 50 Hz, 2 mA at 24V	2 mA at 24V ac 50 Hz, 2 mA at 24V
Delay time I1 to I8 and I9 to I12 (1760-L18-NWN-xx), From 0 to 1 and from 1 to 0		
Debounce ON	80 ms (50 Hz), 66.66 ms (60 Hz)	80 ms (50 Hz), 66.66 ms (60 Hz)
Debounce OFF	20 ms (50 Hz), 16.66 ms (60 Hz)	20 ms (50 Hz), 16.66 ms (60 Hz)
Max. permissible cable length (per input)		
I1 to I8 and 1760-L18NWN-xx I9 to I10	40m (131 ft)	

Specification	1760-L12AWA 1760-L12AWA-NC 1760-L12AWA-ND	1760-L18AWA 1760-L18AWA-EX 1760-L18AWA-EXND 1760-IA12XOW6I ⁽¹⁾
Digital inputs 115/230V ac		
Number	8	12
Status display	LCD (if provided)	LCD (if provided)
Electrical isolation		
To power supply	No	No
Between Inputs	No	No
to the outputs	Yes	Yes
Rated voltage (sinusoidal)		
off state	0 to 40V ac	0 to 40V ac
on state	79 to 264V ac	79 to 264V ac
Rated frequency	50/60 Hz	50/60 Hz
Input current R1 to R12, I1 to I6 (1760-L18AWA-xx also I9 to I12)	0.5 mA at 230V ac 50 Hz, 0.25 mA at 115V ac 60 Hz	0.5 mA at 230V ac, 50 Hz 0.25 mA at 115V ac 60 Hz
Input current I7, I8	6 mA at 230V ac 50 Hz, 4 mA at 115V ac 60 Hz	6 mA at 230V ac 50 Hz, 4 mA at 115V ac 60 Hz
Delay time I1 to I6 and I9 to I12, From 0 to 1 and from 1 to 0		
Debounce ON	80 ms (50 Hz), 66.66 ms (60 Hz)	80 ms (50 Hz), 66.66 ms (60 Hz)
Debounce OFF	20 ms (50 Hz), 16.66 ms (60 Hz)	20 ms (50 Hz), 16.66 ms (60 Hz)
Delay time I7, I8 from 1 to 0		
Debounce ON	160 ms (50 Hz), 150 ms (60 Hz)	80 ms (50 Hz), 66.66 ms (60 Hz)
Debounce OFF	100 ms (50 Hz/60 Hz)	20 ms (50 Hz), 16.66 ms (60 Hz)
Delay time I7, I8 from 0 to 1		
Debounce ON	80 ms (50 Hz), 66.66 ms (60 Hz)	
Debounce OFF	20 ms (50 Hz), 16.66 ms (60 Hz)	
Max. permissible cable length (per input)		
R1 to R12, I1 to I6 and I9 to I12	40m (131 ft)	
I7, I8	100m (328 ft)	

(1) Delay times for expansion modules are circuit delays only. Additional time is needed to transfer the status to the controller. See Table on page 9-2.

DC Models

Specification	1760-L12DWD 1760-L12DWD-ND 1760-L18DWD-EX 1760-L18DWD-EXND	1760-L12BBB 1760-L12BBB-ND 1760-L12BWB 1760-L12BWB-NC 1760-L12BWB-ND	1760-L18BWB-EX 1760-L18BWB-EXND 1760-L20BBB-EX 1760-L20BBB-EXND 1760-IB12X0B8 ⁽¹⁾ 1760-IB1212X0W6I
Digital Inputs:			
Number of Inputs	8 (1760-L12DWD-xx) 12 (1760-L18DWD-xx)	8	12
	2 inputs (I7 and I8), 4 inputs (I7, I8, I11, I12) for 1760-L18xxx and 1760-L20xxx usable as analog inputs		
Status Display	LCD (if provided)		
Electrical Isolation			
To Power Supply	No	No	No
Between Inputs	No	No	No
To the Outputs	Yes	Yes	Yes
Rated Voltage	12V dc	24V dc	24V dc
Off State Voltage	4.0V dc I1 to I8	< 5.0V dc	< 5.0V dc (I1 to I12, R1 to R12)
On State Voltage	8V dc I1 to I8	<ul style="list-style-type: none"> • 15 to 28.8V dc (I1 to I6) • 8 to 28.8V dc (I7, I8) 	<ul style="list-style-type: none"> • 15 to 28.8V dc (I1 to I6, I9 to I12, R1 to R12) • 8 to 28.8V dc (I7, I8)
Input Current	<ul style="list-style-type: none"> • 3.3 mA at 12V dc (I1 to I6) I9 to I12 (1760-L18DWD-xx) • 1.1 mA at 12V dc (I7, I8) 	<ul style="list-style-type: none"> • 3.3 mA at 24V dc (I1 to I6) • 2.2 mA at 24V dc (I7, I8) 	<ul style="list-style-type: none"> • 3.3 mA at 24V dc (I1 to I6, I9 to I12, R1 to R12) • 2.2 mA at 24V dc (I7, I8)
Delay Time from 0 to 1			
Debounce ON	20 ms	20 ms	20 ms
Debounce OFF	Nominal 0.3 ms	Nominal 0.25 ms	Nominal 0.25 ms
Delay Time from 1 to 0			
Debounce ON	20 ms	20 ms	20 ms
Debounce OFF	<ul style="list-style-type: none"> • Nominal 0.3 ms (I1 to I6 and I9 to I10 1760-L18xxx) • Nominal 0.35 ms (I7, I8 and I11 to I12 1760-L18xxx) 	<ul style="list-style-type: none"> • Nominal 0.4 ms (I1 to I6) • Nominal 0.2 ms (I7, I8) 	<ul style="list-style-type: none"> • Nominal 0.4 ms (I1 to I6) • Nominal 0.2 ms (I7, I8)
Cable Length (unshielded)	100m (328 ft)	100m (328 ft)	100m (328 ft)
Analog Inputs:			
Number of Inputs	2 (4 inputs 1760-L18DWD-xx)	2	4
Electrical Isolation			
To Power Supply	No	No	No

Specification	1760-L12DWD 1760-L12DWD-ND 1760-L18DWD-EX 1760-L18DWD-EXND	1760-L12BBB 1760-L12BBB-ND 1760-L12BWB 1760-L12BWB-NC 1760-L12BWB-ND	1760-L18BWB-EX 1760-L18BWB-EXND 1760-L20BBB-EX 1760-L20BBB-EXND 1760-IB12XOB8 ⁽¹⁾ 1760-IB1212XOW6I
To the Digital Inputs	No	No	No
To the Outputs	Yes	Yes	Yes
Input Type	dc voltage	dc voltage	dc voltage
Signal Range	0 to 10V dc	0 to 10V dc	0 to 10V dc
Analog Resolution	0.1V	0.1V	0.1V
Input Impedance	11.2K Ω	11.2K Ω	11.2K Ω
Accuracy of			
Two Pico Devices	$\pm 3\%$ of actual value	$\pm 3\%$ of actual value	$\pm 3\%$ of actual value
Within a Single Device (I7, I8)	$\pm 2\%$ of actual value $\pm 0.12V$	$\pm 2\%$ of actual value $\pm 0.12V$	$\pm 2\%$ of actual value $\pm 0.12V$
Analog to Digital Conversion Time	Debounce ON: 20 ms Debounce OFF: every cycle	Debounce ON: 20 ms Debounce OFF: every cycle	Debounce ON: 20 ms Debounce OFF: every cycle
Input Current	< 1 mA	< 1 mA	< 1 mA
Cable Length (shielded)	30m (98 ft)	30m (98 ft)	30m (98 ft)

(1) Delay times for expansion modules are circuit delays only. Additional time is needed to transfer the status to the controller. See Table on page 9-2.

High-Speed Counters

High-Speed Counter Inputs, I1 to I4	1760-L12BBB, 1760-L12BBB-ND 1760-L12BWB, 1760-L12BWB-NC 1760-L12BWB-ND, 1760-L12DWD 1760-L12DWD-ND 1760-L18BWB-EX, 1760-L18BWB-EXND 1760-L18DWD-EX, 1760-L18DWD-EXND 1760-L20BBB-EX, 1760-L20BBB-EXND
Number	4
Cable Length (shielded)	20 m
High Speed Up and Down Counters	
Counting Frequency	<1 kHz
Pulse Shape	Square Wave
Mark-to-Space Ratio	1:1
Frequency Counters	

High-Speed Counter Inputs, I1 to I4	1760-L12BBB, 1760-L12BBB-ND 1760-L12BWB, 1760-L12BWB-NC 1760-L12BWB-ND, 1760-L12DWD 1760-L12DWD-ND 1760-L18BWB-EX, 1760-L18BWB-EXND 1760-L18DWD-EX, 1760-L18DWD-EXND 1760-L20BBB-EX, 1760-L20BBB-EXND
Counting Frequency	<1 kHz
Pulse Shape	Square Wave
Mark-to-Space Ratio	1:1

Outputs

Relay Outputs

Specification	1760-L12AWA 1760-L12AWA-NC 1760-L12AWA-ND 1760-L12BWB 1760-L12BWB-NC 1760-L12BWB-ND 1760-L12DWD 1760-L12DWD-ND 1760-L12NWN 1760-L12NWN-ND	1760-L18AWA 1760-L18AWA-EX 1760-L18AWA-EXND 1760-L18BWB-EX 1760-L18BWB-EXND 1760-L18DWD-EX 1760-L18DWD-EXND 1760-L18NWN-EX 1760-L18NWN-EXND 1760-IA12XOW6I 1760-IB12XOW6I 1760-OW2
Number of Relay Outputs	4	6 (2 for 1760-OW2)
In Groups of	1 (2 for 1760-OW2)	
Connection of Outputs in Parallel to Increase the Output	Not permissible	
Protection for an Output Relay	Miniature circuit-breaker B16 or 8 A fuse (slow)	
Isolation to Power Supply and Inputs	300V ac reinforced insulation	
Contacts Relays		
Conventional Thermal Current	8 A (10 A UL)	
Recommended for Load	> 500 mA, 12V ac/dc	
Short-Circuit Resistance COS 1	16 A characteristic B (B16) at 600 A	
Short-Circuit Resistance COS 0.5 to 0.7	16 A characteristic B (B16) at 900 A	
Rated Impulse Withstand Voltage U_{imp} Contact/Coil	6 KV	
Rated Insulation Voltage U_i		
Rated Operational Voltage U_e	250V ac	
Isolation to EN 50178 Between Coil and Contact	300V ac reinforced insulation	
Isolation to EN 50178 Between Two Contacts	300V ac reinforced insulation	
Making Capacity		
AC-15 COS $\phi = 0.4$, 250V ac, 3A (600 Ops/h)	300,000 switching operations	
DC-13 L/R ≤ 150 ms, 24V dc, 1A (500 Ops/h)	200,000 switching operations	
Breaking Capacity		
AC-15 COS $\phi = 0.7$ 250V ac, 3 A (600 Ops/h)	300,000 switching operations	
DC-13 L/R ≤ 150 ms 24V DC, 1 A (500 Ops/h)	200,000 switching operations	

Specification	1760-L12AWA 1760-L12AWA-NC 1760-L12AWA-ND 1760-L12BWB 1760-L12BWB-NC 1760-L12BWB-ND 1760-L12DWD 1760-L12DWD-ND 1760-L12NWN 1760-L12NWN-ND	1760-L18AWA 1760-L18AWA-EX 1760-L18AWA-EXND 1760-L18BWB-EX 1760-L18BWB-EXND 1760-L18DWD-EX 1760-L18DWD-EXND 1760-L18NWN-EX 1760-L18NWN-EXND 1760-IA12XOW6I 1760-IB12XOW6I 1760-OW2
Filament Lamp Load	1000 W at 230/240V ac/25,000 operations 500 W at 115/120V ac/25,000 operations	
Fluorescent Tube with Ballast	10 x 58 W at 230/240V ac/25,000 operations	
Conventional Fluorescent Tube, Compensated	1 x 58 W at 230/240V ac/25,000 operations	
Fluorescent Tube, Uncompensated	10 x 58 W at 230/240V ac/25,000 operations	
Relay Operating Frequency		
Mechanical Switching Operations	10 million (10 ⁷)	
Mechanical Switching Frequency	10 Hz	
Resistive Lamp Load	2 Hz	
Inductive Load	0.5 Hz	

Transistor Outputs

Output Specifications

Specification	1760-L12BBB 1760-L12BBB-ND	1760-IB12XOB8 1760-L20BBB-EX 1760-L20BBB-EXND
Number of Outputs	4	8
Output Type	semiconductors	
Rated Voltage	24V dc	
Permissible Range	20.4 to 28.8V dc	
Residual Ripple	≤5%	
Supply Current		
Outputs OFF	18 mA nominal, 32 mA maximum	
Outputs ON	24 mA nominal, 44 mA maximum	

Specification	1760-L12BBB 1760-L12BBB-ND	1760-IB12XOB8 1760-L20BBB-EX 1760-L20BBB-EXND
Reverse Polarity Protection	Yes CAUTION: If voltage is applied to the outputs when the polarity of the power supply is reversed, this will result in a short circuit.	
Isolation from Power Supply and Input Terminals	500V dc	
Rated Current	0.5 A dc maximum	
Lamp Load	5 W	
Off State Leakage Current	< 0.1 mA per channel	
Maximum Output Voltage Drop	1V dc	
Short Circuit Protection	Yes, thermal (detected via diagnostics input I16, I15; R15, R16)	
Short Circuit Tripping Current, I for Load ≤ 10 milli-ohm	0.7 A $\leq I \leq 2$ A (depending on the number of active channels and their load)	
Short Circuit Current	8 A total maximum	16 A total maximum
	16 A peak	32 A peak
Thermal Cutout	Yes	
Maximum Switching Frequency with Constant Resistive Load $R_L < 100 \text{ k}\Omega$	40,000 Hz (depending on circuit diagram and load)	
Parallel Connection of Outputs with Resistive Load; Inductive Load with External Suppression Circuit Combination Within a Group (see page 2-25)	Group 1: Q1 to Q4, S1 to S4	Group 1: Q1 to Q4, S1 to S4 Group 2: Q5 to Q8, S5 to S8
Number of Outputs	4 maximum	
Total Maximum Current	2.0 A	
	CAUTION: Outputs must be actuated simultaneously and for the same time duration.	
Status Display of the Outputs	LCD display (if provided)	

Inductive Load (without external suppression)

An unsuppressed inductive load applies stresses to the transistor output when the load is switched off. It is recommended that all inductive loads be suppressed. To reduce the risk of damage, deratings should be applied to the transistor outputs if inductive loads are not suppressed.

The outputs of the 1760-IB12XOB8 are internally connected in two groups, S1 to S4 and S5 to S8. No more than one unsuppressed load should be operated in each output group. The unsuppressed load should be switched no more frequently than 0.5 Hz (once every two seconds).

Cycle Time**1760-L12xxx**

Function	Number	Time Duration in μs	Total
Basic pulse	1	210	
Refresh	1	3500	
Contacts and bridged contact fields		20	
Coils		20	
Circuit connections from the first one to the last one, with empty ones in between		0	
Connecting lines, only Γ, L, \vdash		20	
Timing relays (see Table below)			
Counters (see Table below)			
Analog value function relays (see Table below)			
Total			

Number	1	2	3	4	5	6	7	8
Timing relays in μs	20	40	80	120	160	200	240	280
Counters in μs	20	50	90	130	170	210	260	310
Analog value processors in μs	80	100	120	140	160	180	220	260

1760-L18xxx

Function	Number	Time Duration (μs)	Total
Basic pulse	1	520	
Refresh		5700	
Contacts and bridged contact fields		40	
Coils		20	
Circuit connections from the first one to the last one, with empty ones in between		70	
Connecting lines, only Γ, L, \vdash		40	
Timing relays (see Table below)			
Counters (see Table below)			
Analog value function relays (see Table below)			
Total			

Number	1	2	3	4	5	6	7	8
Timing relays in μs	40	120	160	220	300	370	440	540
Counters in μs	40	100	160	230	300	380	460	560
Analog value processors in μs	120	180	220	260	300	360	420	500

Dimensions

1760-L12xxx

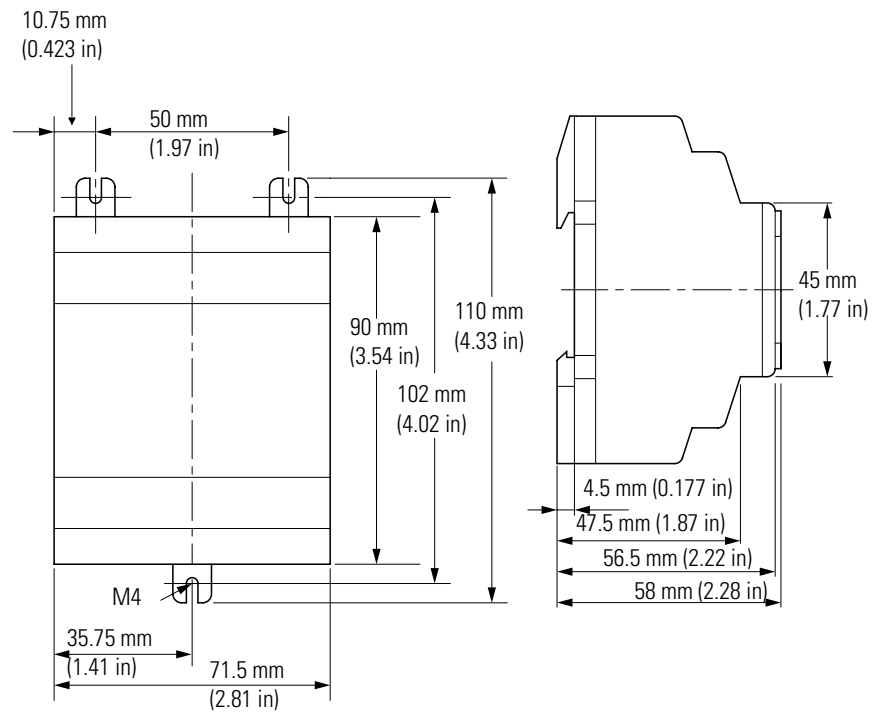

1760-L18xxx, 1760-L20xxx and Expansion Modules

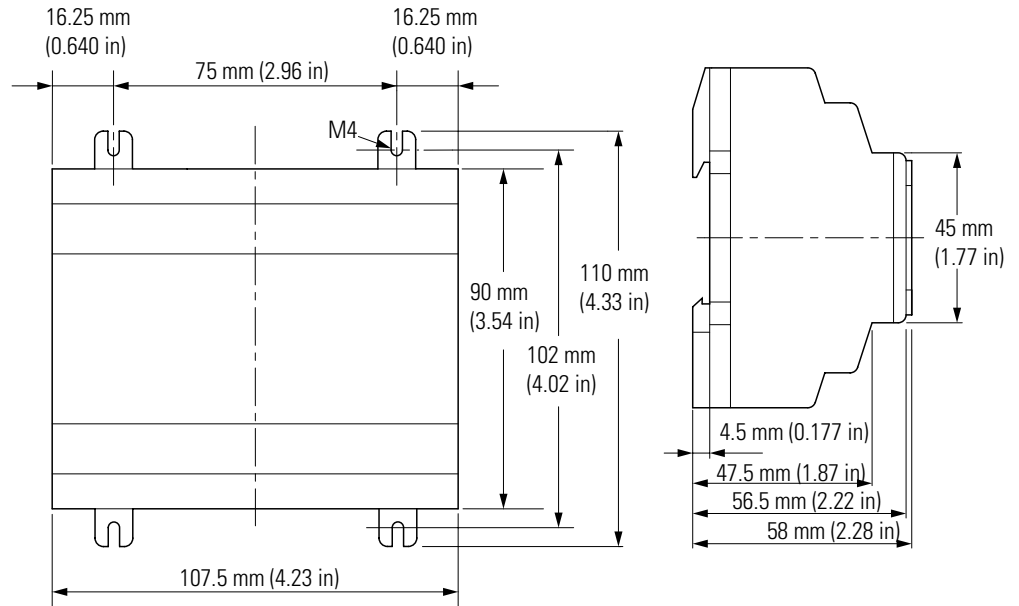

Pico 1760-OW2 Expansion Module

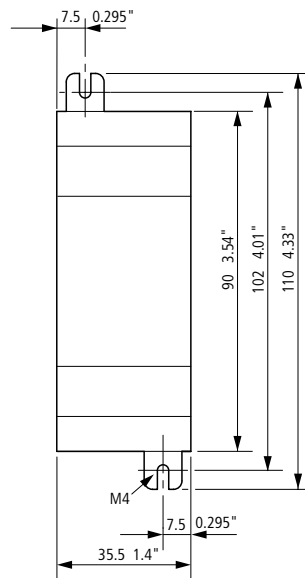

Dimensions of the 1760-RM... Remote Processor modules

176-RM...

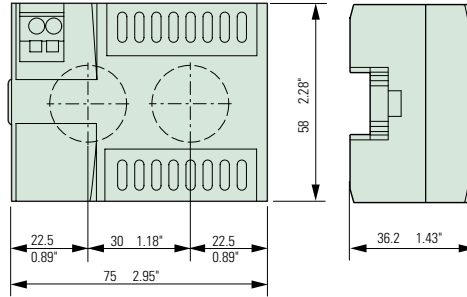

1760-DU... and 176-RM...

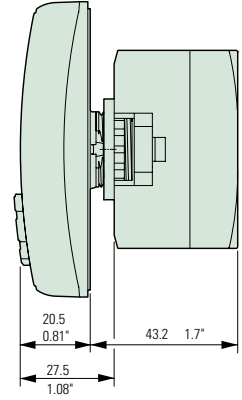















Circuit Diagram Form

See page 4-21 for an example that shows how to use these forms for planning and preparing your Pico circuit diagrams.

Customer: _____ Program: _____

Date: _____ Page: _____

Comment:

	_____
	_____
	_____
	_____
	_____
	_____
	_____
	_____
	_____
	_____
	_____
	_____
	_____
	_____
	_____

Customer: _____ Program: _____

Date: _____ Page: _____

Timing relays

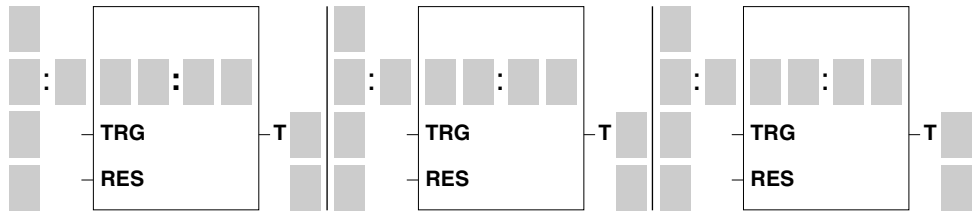

Analog comparators

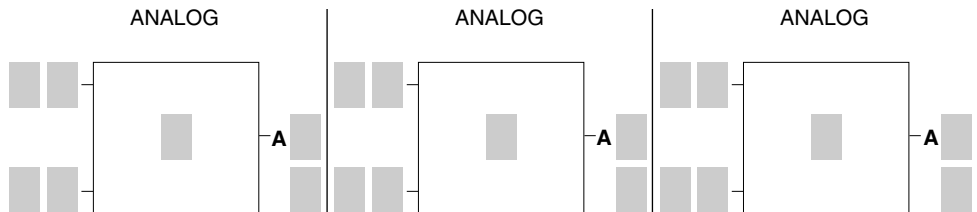

Timing switches

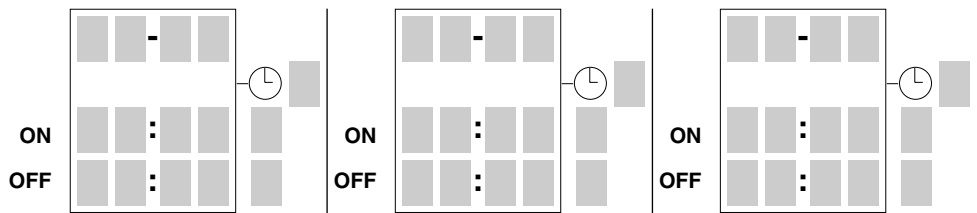

Up/down counters

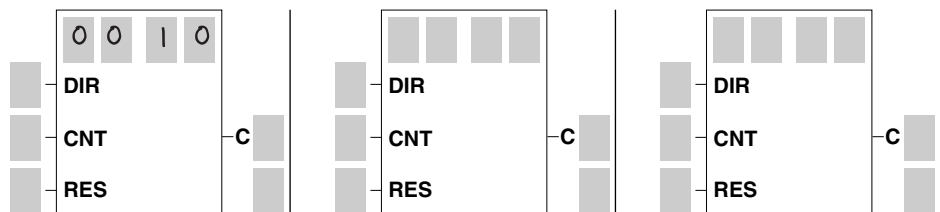

The following terms are used throughout this manual. Refer to the *Allen-Bradley Industrial Automation Glossary*, Publication Number AG-7.1, for a complete guide to Allen-Bradley technical terms.

Analog input - The DC versions of Pico have analog inputs I7 and I8. The input voltage range is 0 V to 10 V. Input data is evaluated by built-in analog comparator function relays.

Circuit connections - Every line in the circuit diagram display represents a circuit connection.

Circuit diagram elements - As in conventional wiring, the circuit diagram is made up of circuit elements. These include input, output and marker relays, plus function relays and the P buttons.

Connect mode - Connect mode is used to wire up the circuit elements in your Pico circuit diagram.

Contact behavior - The contact behavior of any circuit element can be defined as either a break contact or a make contact. Break contact elements are identified by a line on top of the identifier (Exception: conditional jumps).

Entry mode - Entry mode is used to input or modify values when creating circuit diagrams or setting parameters, for example.

Flip-flop relay - An impulse relay is a relay which changes its switching state and stays changed (latched) when a voltage is applied to the relay coil for a short time.

Function relay type - Function relays are provided for more complex switching tasks. Pico features the following types of relay:

- Timing relays
- Time switches
- Counters
- Analog comparators
- Text marker relays

Input - The inputs are used to connect up external contacts. In the circuit diagram, inputs are evaluated via contacts I1 to I12 (or R1 to R12 on the expansion modules). Pico DC units can also receive analog data via inputs I7 and I8.

Interface - The Pico interface is used to exchange and save circuit diagrams to a memory card or PC. Each memory card contains one circuit diagram and its associated Pico settings. The PicoSoft PC software allows you to control Pico from your PC which is connected using the 1760-CBL-PM02 cable.

Memory Module - The memory module is used to store your Pico circuit diagram, together with its parameter and Pico settings. Your data on the memory module will be retained, even if the power supply fails or is switched off. The memory module is inserted into the interface slot on the Pico device.

Operating buttons - Pico has eight operating buttons. These are used to select menu functions and create circuit diagrams. The large round button in the middle is used to move the cursor. DEL, ALT, ESC and OK all perform additional functions.

Operating mode - Pico has two operating modes: RUN and STOP. RUN mode is used to process your circuit diagram (with the controller running continuously). In STOP mode you can create your circuit diagrams.

Output - You can connect various loads to the four Pico outputs, such as contactors, lamps or and motors. In the circuit diagram, the outputs are activated via output relay coils Q1 to Q4 (or Q6) on the controllers or S1 through S6 (or S8) on the expansion modules.

P buttons - The P buttons can be used to simulate four additional inputs which are controlled directly by the four cursor buttons, rather than via external contacts. The relay contacts of P buttons are connected up in the circuit diagram.

Parameters - Parameters enable the user to set the behavior of a function relay. Examples include switching times or counter setpoints. They are set in the parameter display.

Power supply - Pico AC controllers are powered by 120 to 240V ac, 50/60 Hz. The terminals are labeled 'L1' and 'L2'. Pico 1760-LxxBWB controllers are powered by 24V dc. The terminals are labeled '+24V' and 'com'. 1760-LxxDWD controllers are powered by 12V dc. The terminals are labeled '+12V' and 'com'.

Retention - The retentive data is kept even after the Pico power supply is switched off. The following data is retentive:

- Pico circuit diagram
- Parameters, setpoint values
- Text displays
- System settings
- Password entry
- Actual values of marker relays, timing relays, counters

Notes:

Numerics

20 mA sensors 2-21

A

Actual values 4-19

Allen-Bradley

contacting for assistance Preface-3
support Preface-3

AND circuit 4-56

B

Basic circuit

Changeover circuit 4-57
Parallel connection 4-56
Permanent contact 4-55
Series connection 4-56

Break contact 4-4, 4-9

Button

ALT 3-7
OK 3-5

Buttons 1-6

OK 4-3

C

Cable lengths 2-16

Cable protection 2-11

Changeover circuit 4-57

Changing menu level 3-5

Changing to summer time 6-10

Changing to winter time 6-10

Circuit connection

Deleting 4-12
Inserting 3-7, 4-11

Circuit diagram

Checking 4-13
Circuit connection 4-6
Coil field 4-6
Contacts 4-6
Deleting 3-9
Fast entry 3-9
Grid lines 3-5, 4-6
Internal processing 8-1
Loading 5-3, 5-6
Overview 4-6
Storing 5-3, 5-6
Testing 3-8, 4-13
Wiring 4-10
Entry 3-7

Circuit diagram display 3-5, 4-6

Coil field 4-6

Coil function 4-15, 4-16, 4-17

Impulse relays 4-17
Latching relays 4-18
Overview 4-14

common techniques used in this manual

Preface-2

Comparing analog values 4-47

Connecting

20 mA sensors 2-21
Analog inputs 2-19
Contactors, relays 2-22
Light intensity sensors 2-20
Proximity switches 2-17, 2-18
Pushbuttons, switches 2-17, 2-18
Setpoint potentiometers 2-20
Temperature sensors 2-21

Connecting relay outputs 2-22

Connections

Deleting 4-11
Entry 4-10
Position in the circuit diagram 4-6

Contact 4-9

Cursor buttons 4-12
Entry 3-6
Inverting 3-7

Contact fields 4-6

contacting Allen-Bradley for assistance

Preface-3

Contactor 4-15, 4-16, 4-17

**contactors (bulletin 100), surge
suppressors for** 2-14

Contacts

Deleting 4-9
Entry 4-8
Modifying 4-8
Overview 4-4

Counter frequency 4-34

Counter relays 4-32

Parameters 4-35

Cursor display 1-12, 4-3

Cycle 8-1

D

Debounce

Activating 6-10

Delay times

for Pico AC 8-8
for Pico DC 8-7

Deleting retentive actual values 7-2

Deletion, retentive actual values 7-2

Determining counter frequency 4-34

Determining the cycle time 8-3

Dimensions A-1

dimensions

1760-0W2 A-15

E

Entry

Contact 3-6

Error handling 10-1

Example programs 4-55

Examples

Impulse relay 7-6

S/R coil (break contact) 7-5

S/R function 7-7

Timing relay on-delayed 7-9

Timing relay, off-delayed 7-11

Timing relay, single-pulse 7-12

Expansion module inputs 9-1

Expansion module installation 2-3

Expansion module outputs 9-2

F

Flicker effect 7-4

Function relays

Counter relays 4-32

Example 4-21

Overview 4-19

Timing relays 4-26

I

Impulse 7-6

Impulse relays 4-17

Increasing the input current 2-16

Input contacts 4-8

Inserting

Circuit connection 3-7

installing your base unit

using mounting screws 2-5

Interface 5-1

Interference 2-16

Inverting 4-9

J

Jumps 4-53

L

Latching 4-15

Latching relays 4-18

LED 1-8

Light intensity sensors 2-20

Logic tables 4-55

M

Main menu

Selecting 1-7

Make contact 4-4, 4-9

manuals, related Preface-2

Marker relays 4-14, 8-2

Markers 4-14

Markers, retentive 7-4

Memory card

Deleting 5-4

Inserting 5-2

Menu structure 1-9

Message

PROG INVALID 5-4, 5-7, 10-2

Messages

System 10-1

Mode

Changing 3-8

motor starters (bulletin 509)

surge suppressors 2-14

motor starters (bulletin 709)

surge suppressors 2-14

N

NAND circuit 4-56

Negation 4-55

NOT circuit 4-55

O

Operating buttons 1-6

OR circuit 4-56

Output relays 4-8

Overview of Pico 1-2

P

P buttons 4-12

Activating and deactivating 6-11

Parameter display

Counter relays 4-35

Time switches 4-43

Timing relays 4-28

Parameters

Changing 6-7

Changing the switching time 6-8
 Display 6-7
 Power flow display 4-25

Password

Activating 6-3
 Changing 6-5
 Deleting 6-5
 Remove protection 6-5
 Setting 6-2
 Unlocking 6-4

Password incorrect or not known 6-5

P-Buttons 4-12

PC connection 5-5

PicoSoft software 5-5

Power failure 3-3

Power flow display 3-8, 4-12, 4-13,
 4-25

Program examples 4-55

Protecting timer and counter settings
 4-25

publications, related Preface-2

Purpose of this Manual Preface-1

R

Reed relay contacts 2-16

related publications Preface-2

Relay coils

Deleting 4-9
 Entering 3-7

Relay outputs 2-22

Relay types

Overview 4-5

Relays

Coil function 4-14
 Entering 4-8
 Modifying 4-8

relays

surge suppressors for 2-14

Reset 4-18

Restricting the inrush current 2-17

Retention

Setting 7-2

Retention requirements

Permitted markers and function relays
 7-1

Retentive behaviour 7-3

Transfer of circuit diagrams 7-3

Retentive settings 7-1

RUN, Startup behaviour 3-3

RUN/STOP toggle 3-8

S

Set 4-18

Setpoint potentiometers 2-20

Setpoints 4-19, 6-8

Setting the menu language 3-2

Startup behaviour 6-12

After deleting the circuit diagram 6-13

Default setting 6-12

During uploading and downloading to
 card or PC 6-13

Possible faults 6-13

Setting 6-12

Status image 8-1

Suppressing contact bounce 8-7

surge suppressors

for contactor 2-14

for motor starters 2-14

for relays 2-14

recommended 2-14

using 2-12

System menu 1-11

Selecting 1-7

T

Temperature sensors 2-21

Text display 4-50

Time switches

Examples 4-44

Parameters 4-43

Timer and counter settings

protecting 4-25

Timing relays

Flashing 4-31

Off-delayed 4-30

On-delayed 4-29

Parameters 4-28

Retentive 7-8

Single pulse 4-31

Wiring 4-26

Torque 2-8

Transfer cable 5-6

Troubleshooting

contacting Allen-Bradley for assistance
 Preface-3

procedures 10-1

Two-wire proximity switches 2-16

W

Wiring

Backwards 8-2

Relays 4-15
Rules 4-15

X
XOR circuit 4-57

Rockwell Automation Support

Rockwell Automation provides technical information on the web to assist you in using our products. At <http://support.rockwellautomation.com>, you can find technical manuals, a knowledge base of FAQs, technical and application notes, sample code and links to software service packs, and a MySupport feature that you can customize to make the best use of these tools.

For an additional level of technical phone support for installation, configuration and troubleshooting, we offer TechConnect Support programs. For more information, contact your local distributor or Rockwell Automation representative, or visit <http://support.rockwellautomation.com>.

Installation Assistance

If you experience a problem with a hardware module within the first 24 hours of installation, please review the information that's contained in this manual. You can also contact a special Customer Support number for initial help in getting your module up and running:

United States	1.440.646.3223 Monday – Friday, 8am – 5pm EST
Outside United States	Please contact your local Rockwell Automation representative for any technical support issues.

New Product Satisfaction Return

Rockwell tests all of our products to ensure that they are fully operational when shipped from the manufacturing facility. However, if your product is not functioning and needs to be returned:

United States	Contact your distributor. You must provide a Customer Support case number (see phone number above to obtain one) to your distributor in order to complete the return process.
Outside United States	Please contact your local Rockwell Automation representative for return procedure.

www.rockwellautomation.com

Corporate Headquarters

Rockwell Automation, 777 East Wisconsin Avenue, Suite 1400, Milwaukee, WI, 53202-5302 USA, Tel: (1) 414.212.5200, Fax: (1) 414.212.5201

Headquarters for Allen-Bradley Products, Rockwell Software Products and Global Manufacturing Solutions

Americas: Rockwell Automation, 1201 South Second Street, Milwaukee, WI 53204-2496 USA, Tel: (1) 414.382.2000, Fax: (1) 414.382.4444

Europe: Rockwell Automation SA/NV, Vorstlaan/Boulevard du Souverain 36-BP 3A/B, 1170 Brussels, Belgium, Tel: (32) 2 663 0600, Fax: (32) 2 663 0640

Asia Pacific: Rockwell Automation, 27/F Citicorp Centre, 18 Whitfield Road, Causeway Bay, Hong Kong, Tel: (852) 2887 4788, Fax: (852) 2508 1846

Headquarters for Dodge and Reliance Electric Products

Americas: Rockwell Automation, 6040 Ponders Court, Greenville, SC 29615-4617 USA, Tel: (1) 864.297.4800, Fax: (1) 864.281.2433

Europe: Rockwell Automation, Brühlstraße 22, D-74834 Elztal-Dallau, Germany, Tel: (49) 6261 9410, Fax: (49) 6261 17741

Asia Pacific: Rockwell Automation, 55 Newton Road, #11-01/02 Revenue House, Singapore 307987, Tel: (65) 351 6723, Fax: (65) 355 1733